



# K49

## CONTROLLER AND MINI-PROGRAMMER



### Engineering Manual

Code : ISTR-MK49ENG07 - Vr. 0.7 (ENG)

## 1. OUTLINE DIMENSIONS (mm)

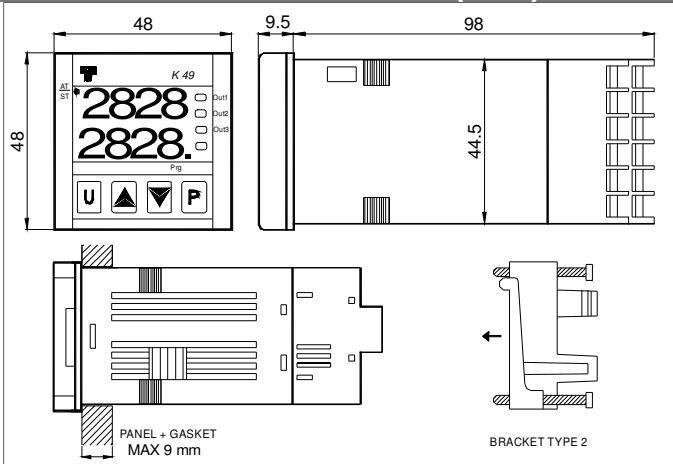

## 2. CONNECTION DIAGRAM

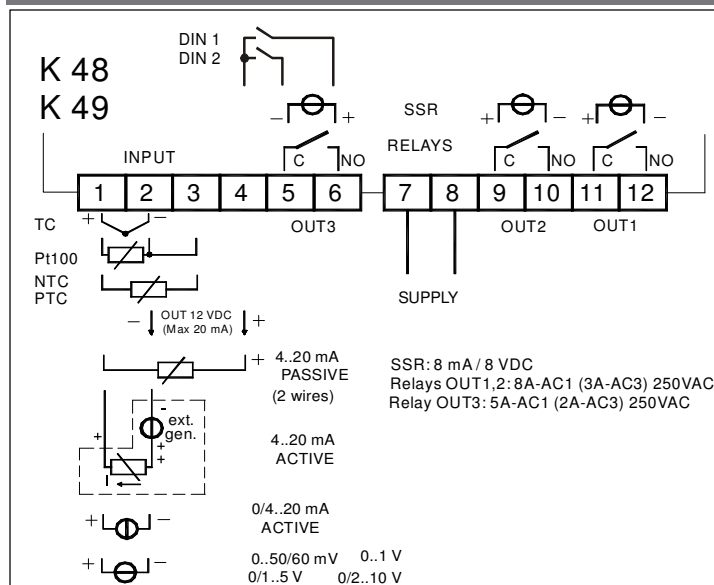

## 2.1 - MOUNTING REQUIREMENTS

This instrument is intended for permanent installation, for indoor use only, in an electrical panel which encloses the rear housing, exposed terminals and wiring on the back. Select a mounting location having the following characteristics:

- 1) it should be easily accessible
- 2) there is minimum vibrations and no impact
- 3) there are no corrosive gases.
- 4) there are no water or other fluid (i.e. condensation).
- 5) the ambient temperature is in accordance with the operative temperature (from 0 to 50 °C).
- 6) the relative humidity is in accordance with the instrument specifications ( 20% to 85 %).

The instrument can be mounted on panel with a maximum thick of 15 mm.

When the maximum front protection (IP65) is desired, the optional gasket must be monted.

## 2.2 GENERAL NOTES ABOUT INPUT WIRING

- 1) Don't run input wires together with power cables.
- 2) External components (like zener barriers, etc.) connected between sensor and input terminals may cause errors in measurement due to excessive and/or not balanced line resistance or possible leakage currents.
- 3) When a shielded cable is used, it should be connected at one point only.
- 4) Pay attention to the line resistance; a high line resistance may cause measurement errors.

## 2.3 THERMOCOUPLE INPUT

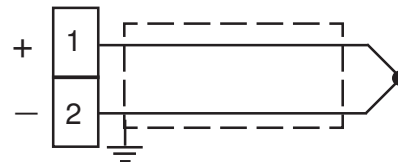

Fig. 3 Thermocouple input wiring

**External resistance:** 100 Ω max, maximum error 0,5 % of span.

**Cold junction:** automatic compensation from 0 to 50 °C.  
**Cold junction accuracy :** 0.1 °C/°C after a warm-up of 20 minutes

**Input impedance:** > 1 MΩ

**Calibration:** according to EN 60584-1.

**NOTE:** for TC wiring use proper compensating cable preferable shielded.

## 2.4 INFRARED SENSOR INPUT

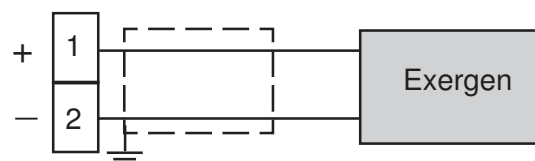

Fig. 3 Infrared input wiring

**External resistance:** don't care condition.

**Cold junction:** automatic compensation from 0 to 50 °C.

**Cold junction accuracy** : 0.1 °C/°C  
**Input impedance**: > 1 MΩ

## 2.5 RTD (Pt 100) INPUT

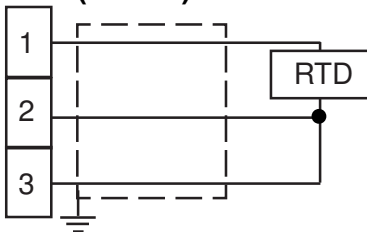

**Fig. 4 RTD input wiring**

**Input circuit**: current injection (135 μA).  
**Line resistance**: automatic compensation up to 20 Ω/ wire with maximum error ± 0.1% of the input span.  
**Calibration**: according to EN 60751/A2.  
**NOTE**: The resistance of the 3 wires **must** be the same.

## 2.6 THERMISTOR INPUT

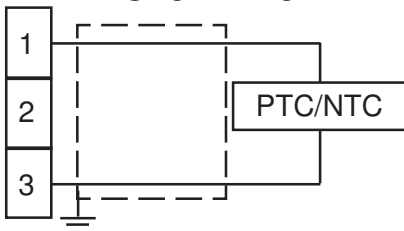

**Fig. 4 PTC / NTC input wiring**

**Input circuit**: current injection (25 μA).  
**Line resistance**: not compensated.

## 2.7 V AND mV INPUT

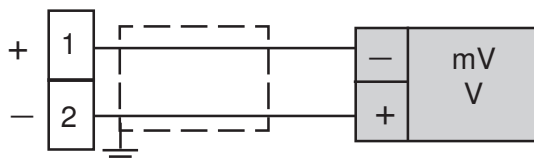

**Fig. 4 V / mV input wiring**

**Input impedance**: > 1 MΩ  
**Accuracy** : ± 0.5 % of Span ± 1 dgt @ 25 °C.

## 2.8 - mA INPUT

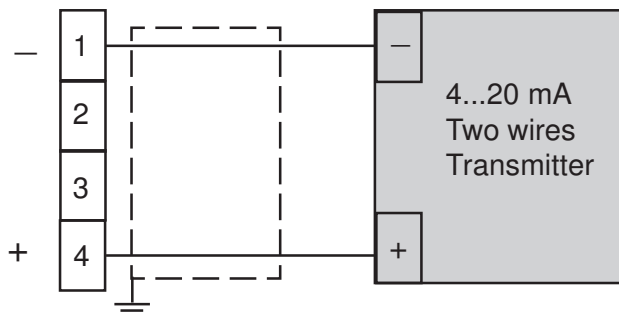

**Fig. 4 0/4-20 mA input wiring for passive transmitter with auxiliary pws**

**Input impedance**: < 51 Ω.  
**Accuracy** : 0.5 % of Span + 1 dgt @ 25 °C.  
**Protection**: NOT protected from short circuit.

**Internal auxiliary PWS**: 10 V DC (± 10%), 20 mA max.

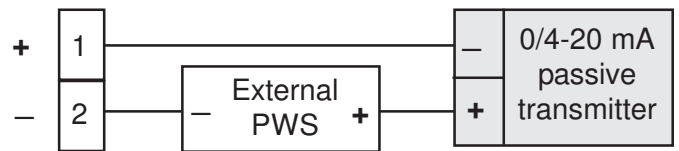

**Fig. 5 0/4-20 mA input wiring for passive transmitter using an external pws**

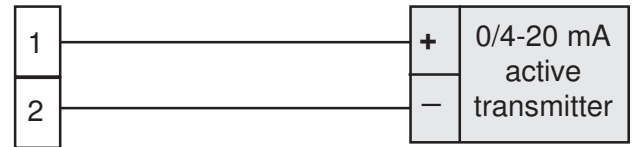
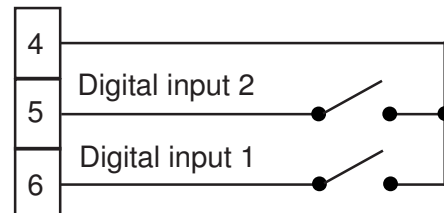

**Fig. 6 0/4-20 mA input wiring for active transmitter**

## 2.9 LOGIC INPUTS

**Safety notes**:

- 1) Do not run logic input wiring together with power cables.
- 2) Use an external dry contact capable to switch 0.5 mA, 5 V DC.
- 3) The instrument needs 150 ms to recognize a contact status variation.
- 4) The logic inputs are **NOT** isolated by the measuring input. A double or reinforced isolation between logic inputs and power line must be assured by the external elements



## 2.10 OUTPUTS

**Safety notes**:

- 1) To avoid electrical shock, connect power line at last.
- 2) For supply connections use No 16 AWG or larger wires rated for at last 75 °C.
- 3) Use copper conductors only.
- 4) SSR outputs are not isolated. A double or reinforced isolation must be assured by the external solid state relays.

### A) OUT 1

Relay

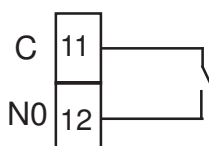

**Out 1 contact rating**:

8 A /250 V cosφ =1

3 A /250 V cosφ =0,4

**Operation**: 1 x 10<sup>5</sup>

### SSR

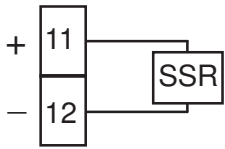

**Logic level 0:**  
 $V_{out} < 0.5 \text{ V DC}$   
**Logic level 1:**  
 $12 \text{ V} \pm 20\% @ 1 \text{ mA}$   
 $10 \text{ V} \pm 20\% @ 20 \text{ mA}$

**NOTE:** This output is not isolated. A double or reinforced isolation between instrument output and power supply must be assured by the external solid state relay.

### b) OUT 2

#### Relay

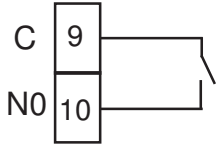

**Out 2 contact rating:**  
 $8 \text{ A} / 250 \text{ V} \cos\phi = 1$   
 $3 \text{ A} / 250 \text{ V} \cos\phi = 0.4$   
**Operation:**  $1 \times 10^5$

#### SSR

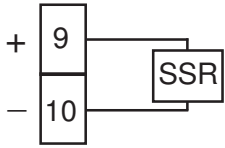

**Logic level 0:**  
 $V_{out} < 0.5 \text{ V DC}$   
**Logic level 1:**  
 $12 \text{ V} \pm 20\% @ 1 \text{ mA}$   
 $10 \text{ V} \pm 20\% @ 20 \text{ mA}$

**NOTE:** This output is not isolated. A double or reinforced isolation between instrument output and power supply must be assured by the external solid state relay.

### b) OUT 3

#### Relay

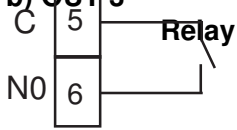

**Out 3 contact rating:**  
 $- 5 \text{ A} / 250 \text{ V} \cos\phi = 1$   
 $- 2 \text{ A} / 250 \text{ V} \cos\phi = 0,4$   
**Operation:**  $1 \times 10^5$

#### SSR

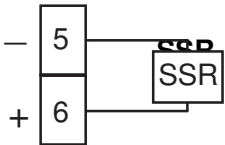

**Logic level 0:**  
 $V_{out} < 0.5 \text{ V DC}$   
**Logic level 1:**  
 $12 \text{ V} \pm 20\% @ 1 \text{ mA}$   
 $10 \text{ V} \pm 20\% @ 20 \text{ mA}$

**NOTE:** This output is not isolated. A double or reinforced isolation between instrument output and power supply must be assured by the external solid state relay.

## 2.11 POWER SUPPLY

**Power consumption:** 5 VA max.

### Supply voltage:

- 100 to 240 V AC ( $\pm 10\%$ )  
 - 24 V AC/DC ( $\pm 10\%$ )

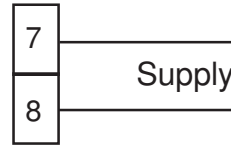

### NOTES:

- 1) Before connecting the instrument to the power line, make sure that line voltage is equal to the voltage shown on the identification label.
- 2) To avoid electrical shock, connect power line at the end of the wiring procedure.
- 3) For supply connections use No 16 AWG or larger wires rated for at last  $75 \text{ }^\circ\text{C}$ .
- 4) Use copper conductors only.
- 5) For 24 V AC/DC the polarity is a do not care condition.
- 6) The power supply input is **NOT** fuse protected. Please, provide a T type 1A, 250 V fuse externally.

### 3. TECHNICAL CHARACTERISTICS

#### 3.1 TECHNICAL SPECIFICATIONS

**Case:** Plastic, self-extinguishing degree: V-0 according to UL 94.

**Front protection:** IP 65 (when the optional panel gasket is mounted) for indoor locations according to EN 60070-1.

**Rear terminals protection:** IP 20 according to EN 60070-1.

**Installation:** Panel mounting

**Terminal block:** 12 screw terminals (screw M3, for cables from  $\phi$  0.25 to  $\phi$  2.5 mm<sup>2</sup> or from AWG 22 to AWG 14 ) with connection diagrams.

**Dimensions:** 48 x 48 mm, depth 98 mm

**Cutout:** 45 (-0 a + 0,5 mm) x 45 (-0 a + 0,5 mm)

**Weight:** 180 g max.

**Power supply:**

- 24 V AC/DC ( $\pm$  10 % of the nominal value).
- 100 to 240 V AC ( $\pm$  10 % of the nominal value).

**Power consumption:** 5 VA max.

**Insulation voltage:**

2300 V rms according to EN 61010-1.

**Display:** 4 digit double display, red and green h 7 mm

**Display updating time:** 500 ms.

**Sampling time:** 130 ms.

**Resolution:** 30000 counts.

**Total Accuracy:**  $\pm$  0.5% F.S.V.  $\pm$  1 digit @ 25°C of room temperature.

**Common mode rejection:** 120 dB at 50/60 Hz.

**Normal mode rejection:** 60 dB at 50/60 Hz.

**Electromagnetic compatibility and safety requirements:**

Compliance: directive EMC 2004/108/CE (EN 61326-1), directive LV 2006/95/CE (EN 61010-1)

**Installation category:** II

**Pollution category:** 2

**Temperature drift:** It is part of the global accuracy.

**Operating temperature:** from 0 to 50°C (from 32 to 122°F).

**Storage temperature:** -30 to +70°C (-22 to 158°F)

**Humidity:** from 20 % to 85% RH, non condensing.

**Protections:** WATCH DOG (hardware/software) for the automatic restart.

### 3.2 - HOW TO ORDER

#### Model

K49 - = Regulator

K49T = Regulator + timer

K49P = Regulator + timer + programmer

#### Power supply

L = 24 V AC/DC

H = 100 to 240 V AC

#### Input

C = J, K, R, S, T, PT100, 0/12...60 mV

E = J, K, R, S, T, PTC, NTC, 0/12...60mV

I = 0/4...20 mA

V = 0...1V, 0/1...5V, 0/2...10V

#### Out 1

R = Relay SPST-NO 8A on res. load

O = VDC for SSR

#### Out 2

- = Not available

R = Relay SPST-NO 8A on res. load

O = VDC for SSR

#### Out 3 and digital inputs

- = Not available

R = Relay SPST 5A on res. load

O = VDC for SSR

D = 2 digital inputs



## 4. CONFIGURATION PROCEDURE

### 4.1 INTRODUCTION

When the instrument is powered, it starts immediately to work according to the parameters values loaded in its memory.

The instrument behaviour and its performances are governed by the value of the memorized parameters. At the first start up the instrument will use a "default" parameter set (factory parameter set); this set is a generic one (e.g. a TC J input is programmed).

We recommend that you modify the parameter set to suit your application (e.g. set the right input type, Control strategy, define an alarm, etc.)

To change these parameters you will need to enter the "Configuration procedure".

#### 4.1.1 ACCESS LEVELS TO THE PARAMETER MODIFICATION AND THEIR PASSWORD

The instrument have one complete parameter set. We call this set "configuration parameter set" (or "configuration parameters").

The access to the configuration parameters is protected by a programmable password (password level 3). The configuration parameters are collected in various groups. Every group defines all parameters related with a specific function (E.g. control, alarms, output functions).

**Note** the instrument will show only the parameters consistent with the specific hardware and in accordance with the value assigned to the previous parameters (e.g. if you set an output as "not used" the instrument will mask all other parameters related with this output).

### 4.2 INSTRUMENT BEHAVIOUR AT POWER UP

At power up the instrument can start in one of the following mode depending on its configuration:

#### Auto mode without program functions

- The upper display will show the measured value
- The lower display will show the Set point value
- The decimal figure of the less significant digit of the lower display is OFF
- The instrument is performing the standard closed loop control.

#### Manual mode (OPLO)

- The upper display will show the measured value
- The lower display will show alternately the power output and the message <<OPLO>>.
- The instrument does not perform Automatic control
- The control output is equal to 0% and can be manually modified by ▲ and ▼ buttons.

#### Stand by mode (St.bY)

- The upper display will show the measured value

- The lower display will show alternately the set point value and the message <<St.bY>> or <<od>>.
- The instrument does not perform any control (the control outputs are OFF).
- The instrument is working as an indicator.

#### Auto mode with automatic program start up.

- The upper display will show the measured value
- The lower display will show one of the following information:
  - the operative set point (when it is performing a ramp)
  - the time of the segment in progress (when it is performing a soak).
  - the set point value alternate with the message <St.bY>.
- In all cases, the decimal figure of the less significant digit of the lower display is lit.

**We define all the above described conditions as "Standard Display".**

### 4.3 HOW TO ENTER INTO THE CONFIGURATION MODE

- 1) Push the P button for more than 3 seconds. The upper display will show < PASS > while the lower display will show 0.

- 2) Using ▲ and/or ▼ buttons set the programmed password.

#### NOTES:

- a) The factory default password for configuration parameters is equal to 30.
- b) All parameter modification are protected by a time out. If no button is pressed for more than 10 second the instrument return automatically back to the Standard display, the new value of the last selected parameter is lost and the parameter modification procedure is closed.

When you desire to remove the time out (e.g. for the first configuration of an instrument) you can use a password equal to 1000 plus the programmed password (e.g. 1000 + 30 [default] = 1030).

It is always possible to end manually the parameter configuration procedure (see the next paragraph).

- c) During parameter modification the instrument continue to perform the control. In certain conditions, when a configuration change can produce a heavy bump to the process, it is advisable to temporarily stop the controller from controlling during the programming procedure (its control output will be Off)

A password equal to 2000 + the programmed value (e.g. 2000 + 30 = 2030).

The control will restart automatically when the configuration procedure will be manually closed.

- 3) Push the P button

If the password is correct the display will show the acronym of the first parameter group preceded by the

symbol  symbol — .

In other words the upper display will show



The instrument is in configuration mode.

#### 4.4 HOW TO EXIT FROM THE CONFIGURATION MODE

Push **U** button for more than 5 seconds

The instrument will come back to the "standard display"

#### 4.5 KEYBOARD FUNCTION DURING PARAMETER MODIFICATION

**U** A short press allows you to exit from the current parameter group and select a new parameter group

A long press allows you to close the configuration parameter procedure (the instrument will come back to the "standard display").

**P** When the upper display is showing a group and the lower display is blank, It allows you to enter in the selected group.

When the upper display is showing a parameter and the lower display is showing its value, it allows you to memorize the selected value and to go to the next parameter within the same group.

**▲** it allows you to increase the value of the selected parameter

**▼** it allows you to decrease the value of the selected parameter

**U** + **P** These allows you to return to the previous group. Proceed as follows:

Push the U button and maintaining the pressure push the P button than release both buttons.

**NOTE:** The group selection is cyclic as well as the selection of the parameters in a group.

#### 4.6 FACTORY RESET - DEFAULT PARAMETER LOADING PROCEDURE

Some times, e.g. when you re-configure an instrument previously used for other works or from other people or when you have made too many errors during configuration and you decided to re-configure the instrument, it is possible to restore the factory configuration.

This action allows you to put the instrument in a defined condition (in the same condition it was at the first power up).

The default data are the typical values loaded in the instrument prior to shipment from factory.

To load the factory default parameter set, proceed as follows:

- 1) Press the P button for more than 5 seconds
- 2) The upper display will show "PASS" while the lower display will show "0".
- 3) By **▲** and **▼** button set the value -481.
- 4) Push P button.

- 5) The instrument will turn OFF all LED for some seconds, than the upper display will show "dELt" (default) and than all LED are turned ON for 2 seconds. At this point the instrument it will restart as for a new power up.

The procedure is complete.

**Note:** the complete list of the default parameter is available in Appendix A.

#### 4.7 ALL CONFIGURATION PARAMETERS

In the following pages we will describe all the parameters of the instrument. However, the instrument will only show the parameters applicable to its hardware options in accordance with the specific instrument configuration (i.e. setting AL1t [Alarm 1 type] equal to <<nonE>> [not used], all parameters related with the alarm 1 will be skipped).

##### J inP GROUP - Main and auxiliary input configuration

##### [2] SEnS - Input type

**Available:** Always

**Range:**

When the code of the input type is equal to C (see Ordering Code at page 29)

J	= TC J	(0 to 1000 °C/ 32 to 1832 °F)
crAL	= TC K	(0 to 1370 °C/ 32 to 2498 °F)
S	= TC S	(0 to 1760 °C/ 32 to 3200 °F)
r	= TC R	(0 to 1760 °C/ 32 to 3200 °F)
t	= TC T	(0 to 400 °C/ 32 to 752 °F)
ir.J	= Exergen IRS J	(0 to 1000 °C/ 32 to 1832 °F)
ir.cA	= Exergen IRS K	(0 to 1370 °C/ 32 to 2498 °F)
Pt1	= RTD Pt 100	(-200 to 850 °C/-328 to 1562 °F)
0.50	= 0 to 50 mV linear	
0.60	= 0 to 60 mV linear	
12.60	= 12 to 60 mV linear	

When the code of the input type is equal to E

J	= TC J	(0 to 1000 °C/ 32 to 1832 °F)
crAL	= TC K	(0 to 1370 °C/ 32 to 2498 °F)
S	= TC S	(0 to 1760 °C/ 32 to 3200 °F)
r	= TC R	(0 to 1760 °C/ 32 to 3200 °F)
t	= TC T	(0 to 400 °C/ 32 to 752 °F)
ir.J	= Exergen IRS J	(0 to 1000 °C/ 32 to 1832 °F)
ir.cA	= Exergen IRS K	(0 to 1370 °C/ 32 to 2498 °F)
Ptc	= PTC KTY81-121	(-55 to 150 °C/-67 to 302 °F)
ntc	= NTC 103-AT2	(-50 to 110 °C/-58 to 230 °F)
0.50	= 0 to 50 mV linear	
0.60	= 0 to 60 mV linear	
12.60	= 12 to 60 mV linear	

When the code of the input type is equal to I

0.20	= 0 to 20 mA linear
4.20	= 4 to 20 mA linear

When the code of the input type is equal to V

0.1	= 0 to 1 V linear
0.5	= 0 to 5 V linear

- 1.5 = 1 to 5 V linear
- 0.10 = 0 to 10 V linear
- 2.10 = 2 to 10 V linear

**Note:**

- When a TC input is selected and a decimal figure is programmed (see the next parameter) the maximum displayed value become 999.9 °C or 999.9 °F.
- **Every** change of the SEnS parameter setting will force the following change:
  - [3] dP = 0
  - [129] ES.L = -1999
  - [130] ES.H = 9999

**[3] dP - Decimal point position**

**Available:** Always

**Range:**

- When [2] SenS = Linear input: 0 to 3.
- When [2] SenS different from linear input: 0 or 1

**Note:** Every change of the dP parameter setting will produce a change of the parameters related with it (e.g. set points, proportional band, etc.)

**[4] SSc – Initial scale read-out for linear inputs**

**Available:** when a linear input is selected by [2] SenS.

**Range:** -1999 to 9999

**Notes:**

- It allows the scaling of the analogue input to set the minimum displayed/measured value  
The instrument will show a measured value up to 5% less than SSc value and then it will show an underrange error.
- It is possible to set a initial scale read-out higher than the full scale read-out in order to obtain a reverse read-out scaling  
E.g. 0 mA = 0 mBar and 20 mA = - 1000 mBar (vacuum).

**[5] FSc - Full scale read-out for linear input**

**Available:** when a linear input is selected by [2] SenS.

**Range:** -1999 to 9999

**Notes:**

- It allows the scaling of the analogue input to set the maximum displayed/measured value  
The instrument will show a measured value up to 5% higher than [5] FSc value and then it will show an overrange error.
- It is possible to set a full scale read-out lower than the initial scale read-out in order to obtain a reverse read-out scaling  
E.g. 0 mA = 0 mBar and 20 mA = - 1000 mBar (vacuum).

**[6] unit - Engineering unit**

**Available:** when a temperature sensor is selected by [2] SenS parameter.

**Range:**

- °C = Centigrade
- °F = Fahrenheit

**[7] FiL - Digital filter on the measured value**

**Available:** Always

**Range:** oFF (No filter) 0.1 to 20.0 s

**Note:** this is a first order digital filter applied on the measured value. For this reason it will affect both the measured value but also the control action and the alarms behaviour.

**[8] inE - Selection of the Sensor Out of Range type that will enable the safety output value**

**Available:** Always

**Range:**

- our = when an **overrange** or an **underrange** is detected, the power output will be forced to the value of [9] oPE parameter.
- or = when an **overrange** is detected, the power output will be forced to the value of [9] oPE parameter.
- ur = when an **underrange** is detected, the power output will be forced to the value of [9] oPE parameter.

**[9] oPE - Safety output value**

**Available:** Ever

**Range:** -100 to 100 % (of the output).

**Notes:**

- When the instrument is programmed with one control action only (heat or cool), setting a value outside of the available output range, the instrument will use Zero. E.g. when heat action only has been programmed, and oPE is equal to -50% (cooling) the instrument will use the zero value.
- When ON/OFF control is programmed and an out of range is detected, the instrument will perform the safety output value using a fixed cycle time equal to 20 seconds.

**[10] diF1 - Digital input 1 function**

**Available:** when the instrument is equipped with digital inputs.

**Range:**

- oFF = No function
- 1 = Alarm Reset [status]
- 2 = Alarm acknowledge (ACK) [status].
- 3 = Hold of the measured value [status].
- 4 = Stand by mode of the instrument [status]  
When the contact is closed the instrument operates in stand by mode.
- 5 = HEAT with SP1 and Cool with "SP2" [status] (see "Note about digital inputs")
- 6 = Timer Run/Hold/Reset [transition]  
Short closure allows to start timer execution and to suspend it while a long closure (longer than 10 seconds) allows to reset the timer.
- 7 = Timer Run [transition] a short closure allows to start timer execution.
- 8 = Timer reset [transition] a short closure allows to reset timer count.
- 9 = Timer run/hold [Status]  
- Contact closure = timer RUN

- contact open = timer Hold
- 10 = Program Run [transition]  
The first closure allows to start program execution but a second closure **restart** the program execution from the beginning.
- 11 = Program Reset [transition]  
A contact closure allows to reset program execution.
- 12 = Program Hold [transition]  
The first closure allows to hold program execution and a second closure continue program execution.
- 13 = Program Run/Hold [status]  
When the contact is closed the program is running.
- 14 = Program Run/Reset [status]  
Contact closed - Program run  
Contact open - Program reset
- 15 = Instrument in Manual mode (Open Loop) [status]
- 16 = Sequential set point selection [transition] (see "Note about digital inputs")
- 17 = SP1 / SP2 selection [status]
- 18 = Binary selection of the set point made by digital input 1 (less significant bit) and digital input 2 (most significant bit) [status].
- 19 = Digital input 1 will work in parallel to the ▲ button while digital input 2 will work in parallel to the ▼ button.

**[11] diF2 - Digital input 2 function**

**Available:** when the instrument is equipped with digital inputs.

**Range:**

- oFF = No function
- 1 = Alarm Reset [status]
- 2 = Alarm acknowledge (ACK) [status].
- 3 = Hold of the measured value [status].
- 4 = Stand by mode of the instrument [status]  
When the contact is closed the instrument operates in stand by mode.
- 5 = HEAt with SP1 and CoOL with "SP2" [status] (see "Note about digital inputs")
- 6 = Timer Run/Hold/Reset [transition]  
Short closure allows to start timer execution and to suspend it while a long closure (longer than 10 seconds) allows to reset the timer.
- 7 = Timer Run [transition] a short closure allows to start timer execution.
- 8 = Timer reset [transition] a short closure allows to reset timer count.
- 9 = Timer run/hold [Status]  
- Contact closure = timer RUN  
- contact open = timer Hold
- 10 = Program Run [transition]  
The first closure allows to start program execution but a second closure **restart** the program execution from the beginning.

- 11 = Program Reset [transition]  
A contact closure allows to reset program execution.
- 12 = Program Hold [transition]  
The first closure allows to hold program execution and a second closure continue program execution.
- 13 = Program Run/Hold [status]  
When the contact is closed the program is running.
- 14 = Program Run/Reset [status]  
Contact closed - Program run  
Contact open - Program reset
- 15 = Instrument in Manual mode (Open Loop) [status]
- 16 = Sequential set point selection [transition] (see "Note about digital inputs")
- 17 = SP1 / SP2 selection [status]
- 18 = Binary selection of the set point made by digital input 1 (less significant bit) and digital input 2 (most significant bit) [status].
- 19 = Digital input 1 will work in parallel to the ▲ button while digital input 2 will work in parallel to the ▼ button.

**Notes about digital inputs**

- 1) When diF1 or diF2 (e.g. diF1) are equal to 5 the instrument operates as follows:
  - when the contact is open, the control action is an heating action and the active set point is SP1.
  - when the contact is closed, the control action is a cooling action and the active set point is SP2.
- 2) When diF1 is equal to 18, diF2 setting is forced to 18 and diF2 value and cannot perform another additional function.
- 3) When diF1 and diF2 are equal to 18, the set point selection will be in accordance with the following table
 

Dig In1	dig.In2	Operative set point
Off	Off	= Set point 1
On	Off	= Set point 2
Off	On	= Set point 3
On	On	= Set point 4
- 4) When diF1 is equal to 19, diF2 setting is forced to up.du and 19 value and cannot perform another additional function.
- 5) When a "Sequential set point selection" is used, every closure of of the logic input increase the value of SPAT (active set point) of one step.  
The selection is cyclic -> SP1 -> SP2 -> SP3 -> SP4

**Output group - Output parameters**

**[12] o1F - Out 1 function**

**Available:** Always

**Range:**

- nonE = Output not used. With this setting the status



of the this output can be driven directly from serial link.

H.rEG = Heating output  
c.rEG = Cooling output  
AL = Alarm output  
t.out = Timer output  
t.HoF = Timr out - OFF in Hold  
P.End = Program end indicator  
P.HLd = Program hold indicator  
P. uit = Program wait indicator  
P.run = Program run indicator  
P.Et1 = Program Event 1  
P.Et2 = Program Event 2  
or.bo = Out-of-range or burn out indicator  
P.FAL = Power failure indicator  
bo.PF = Out-of-range, burn out and Power failure indicator.  
diF1 = The output repeates the digital input 1 status  
diF2 = The output repeates the digital input 2 status  
St.By = Stand By status indicator

#### Notes:

- When two or more outputs are programmed in the same way, these outputs will be driven in parallel.
- The power failure indicator will be reset when the instrument detect an alarm reset command by U key, digital input or serial link.
- When no control output is programmed, all the relative alarm (when present) will be forced to "nonE" (not used).

#### [13] o1.AL – Alarms linked up with the out 1

**Available:** when [12] o1F = AL

**Range:** 0 to 15 with the following rule.

+1 = Alarm 1  
+2 = Alarm 2  
+4 = Alarm 3  
+8 = loop break alarm

**Example 1:** Setting 3 (2+1) the output will be driven by the alarm 1 and 2 (OR condition).

**Example 2:** Setting 13 (8+4+1) the output will be driven by alarm 1 + alarm 3 + loop break alarm.

#### [14] o1Ac – Out 1 action

**Available:** when [12] o1F is different from "nonE"

**Range:**

dir = Direct action  
rEV = Reverse action  
dir.r = Direct action with revers LED indication  
rEV.r = Reverse action with reverse LED indication.

#### Notes:

- Direct action: the output repeats the status of the driven element.

**Example:** the output is an alarm output with direct action. When the alarm is **ON**, the relay will be energized (logic output 1).

- Reverse action: the output status is the opposite of the status of the driven element.

**Example:** the output is an alarm output with reverse action. When the alarm is **OFF**, the relay will be energized (logic output 1). This setting is usually named "fail-safe" and it is generally used in dangerous process in order to generate an alarm when the instrument power supply goes OFF or the internal watchdog starts.

#### [15] o2F - Out 2 function

**Available:** When the instrument has out 2 option.

**Range:**

nonE = Output not used. With this setting the status of the this output can be driven directly from serial link.

H.rEG = Heating output  
c.rEG = Cooling output  
AL = Alarm output  
t.out = Timer output  
t.HoF = Timr out - OFF in Hold  
P.End = Program end indicator  
P.HLd = Program hold indicator  
P. uit = Program wait indicator  
P.run = Program run indicator  
P.Et1 = Program Event 1  
P.Et2 = Program Event 2  
or.bo = Out-of-range or burn out indicator  
P.FAL = Power failure indicator  
bo.PF = Out-of-range, burn out and Power failure indicator.  
diF1 = The output repeates the digital input 1 status  
diF2 = The output repeates the digital input 2 status  
St.By = Stand By status indicator

For other details see [12] O1F parameter

#### [16] o2.AL – Alarms linked up with Out 2

**Available:** when [15] o2F = AL

**Range:** 0 to 15 with the following rule.

+1 = Alarm 1  
+2 = Alarm 2  
+4 = Alarm 3  
+8 = loop break alarm

For more details see [13] o1.AL parameter

#### [17] o2Ac – Out 2 action

**Available:** when [15] o2F is different from "nonE"

**Range:**

dir = Direct action  
rEV = Reverse action  
dir.r = Direct action with revers LED indication  
rEv.r = Reverse action with reverse LED indication.

For more details see [14] o1.Ac parameter.

#### [18] o3F - Out 3 function

**Available:** When the instrument has out 3 option

**Range:**

nonE = Output not used. With this setting the status of the this output can be driven directly from serial link.

H.rEG = Heating output  
 c.rEG = Cooling output  
 AL = Alarm output  
 t.out = Timer output  
 t.HoF = Timr out - OFF in Hold  
 P.End = Program end indicator  
 P.HLd = Program hold indicator  
 P. uit = Program wait indicator  
 P.run = Program run indicator  
 P.Et1 = Program Event 1  
 P.Et2 = Program Event 2  
 or.bo = Out-of-range or burn out indicator  
 P.FAL = Power failure indicator  
 bo.PF = Out-of-range, burn out and Power failure indicator.

diF1 = The output repeats the digital input 1 status  
 diF2 = The output repeats the digital input 2 status  
 St.By = Stand By status indicator

For other details see [12] O1F parameter.

### [19] o3.AL – Alarms linked up with Out 3

**Available:** when [18] o3F = AL

**Range:** 0 to 15 with the following rule.

+1 = Alarm 1  
 +2 = Alarm 2  
 +4 = Alarm 3  
 +8 = loop break alarm

For more details see [13] o1.AL parameter

### [20] o3Ac – Out 3 action

**Available:** when [18] o3F is different from “nonE”

**Range:**

dir = Direct action  
 rEV = Reverse action  
 dir.r = Direct action with revers LED indication  
 rEV.r = Reverse action with reverse LED indication.

For more details see [14] o1.Ac parameter.

### [21] o4F - Out 4 function

**Available:** When the instrument has out 4 option

**Range:**

nonE = Output not used. With this setting the status of the this output can be driven directly from serial link.

H.rEG = Heating output  
 c.rEG = Cooling output  
 AL = Alarm output  
 t.out = Timer output  
 t.HoF = Timr out - OFF in Hold  
 P.End = Program end indicator  
 P.HLd = Program hold indicator  
 P. uit = Program wait indicator  
 P.run = Program run indicator  
 P.Et1 = Program Event 1  
 P.Et2 = Program Event 2  
 or.bo = Out-of-range or burn out indicator  
 P.FAL = Power failure indicator  
 bo.PF = Out-of-range, burn out and Power failure indicator.

diF1 = The output repeats the digital input 1 status  
 diF2 = The output repeats the digital input 2 status  
 St.By = Stand By status indicator  
 For other details see [12] O1F parameter.

### [22] o4.AL – Alarms linked up with Out 4

**Available:** when [21] o4F = AL

**Range:** 0 to 15 with the following rule.

+1 = Alarm 1  
 +2 = Alarm 2  
 +4 = Alarm 3  
 +8 = loop break alarm

For more details see [13] o1.AL parameter

### [23] o4Ac – Out 4 action

**Available:** when [21] o4F is different from “nonE”

**Range:**

dir = Direct action  
 rEV = Reverse action  
 dir.r = Direct action with revers LED indication  
 rEV.r = Reverse action with reverse LED indication.

For more details see [14] o1.Ac parameter.

## ] AL1 Group - Alarm 1 parameters

### [24] AL1t - Alarm 1 type

**Available:** Always

**Range:**

When one or more outputs are programmed as control output

nonE = Alarm not used  
 LoAb = Absolute low alarm  
 HiAb = Absolute high alarm  
 LHAb = Absolute band alarm  
 LodE = Deviation low alarm (relative)  
 HidE = Deviation high alarm (relative)  
 LHdE = Relative band alarm.

When no output is programmed as control output

nonE = Alarm not used  
 LoAb = Absolute low alarm  
 HiAb = Absolute high alarm  
 LHAb = Absolute band alarm

**Notes:**

- The relative and deviation alarms are relative” to the operative set point value.

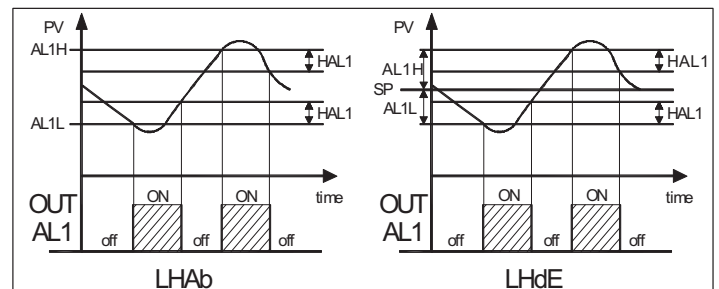

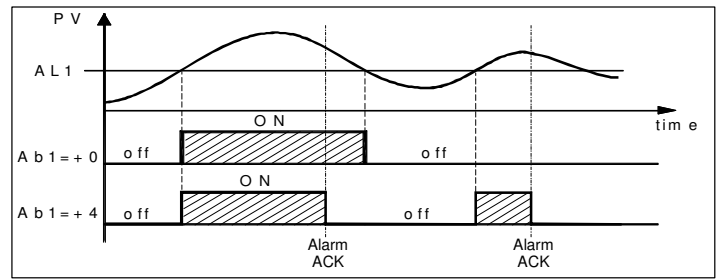
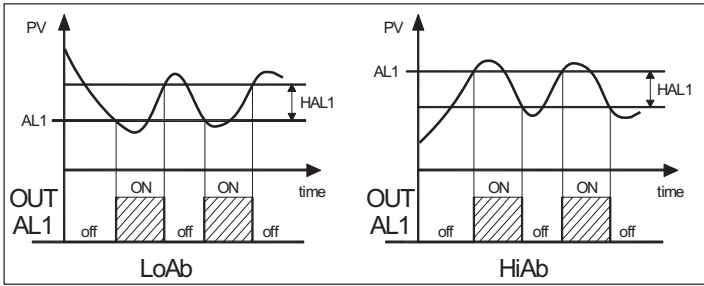

**[25] Ab1 – Alarm 1 function**

**Available:** when [24] AL1t is different from “nonE”

**Range:** 0 to 15 with the following rule:

- +1 = Not active at power up.
- +2 = Latched alarm (manual reset)
- +4 = Acknowledgeable alarm
- +8 = Relative alarm not active at set point change

**Example:** setting Ab1 equal to 5 (1+4) the alarm 1 will be “not active at power up” and “Acknowledgeable”.

**Notes:**

- The “not active at power up” selection allows you to inhibit the alarm function at instrument power up or when the instrument detects a transfer from
  - manual mode (oplo) to auto mode
  - Stand-by mode to auto mode.
- The alarm will be automatically enabled when the measured value reaches, for the first time, the alarm threshold plus or minus the hysteresis (in other words, when the initial alarm condition disappears).

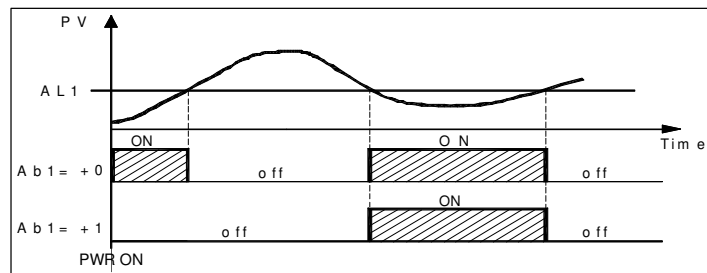

- A “Latched alarm” (manual reset) is an alarm that will remain active even if the conditions that generated the alarm no longer persist. Alarm reset can be done only by an external command (U button, digital inputs or serial link).

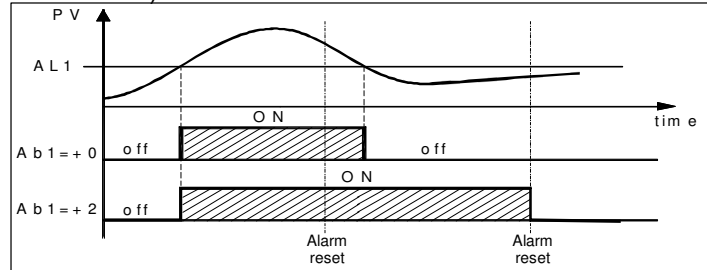

- An “Acknowledgeable” alarm is an alarm that can be reset even if the conditions that generated the alarm are still present. Alarm acknowledge can be done only by an external command (U button, digital inputs or serial link).

- A “relative alarm not active at set point change” is an alarm that masks the alarm condition after a set point change until process variable reaches the alarm threshold plus or minus hysteresis.

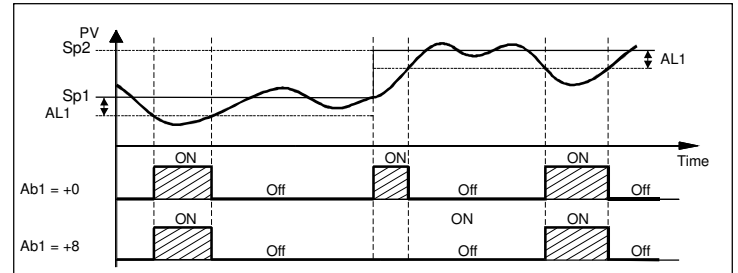

- The instrument does not memorize in EEPROM the alarm status. For this reason, the alarm status will be lost if a power down occurs.

**[26] AL1L - For High and low alarms, it is the low limit of the AL1 threshold**

- For band alarm, it is low alarm threshold

**Available:** when [24] AL1t is different from “nonE”

**Range:** from - 1999 to [27] AL1H engineering units.

**[27] AL1H - For High and low alarms, it is the high limit of the AL1 threshold**

- For band alarm, it is high alarm threshold

**Available:** when [24] AL1t is different from “nonE”

**Range:** from [26] AL1L to 9999 engineering units.

**[28] AL1- Alarm 1 threshold**

**Available:** when

- [24] AL1t = LoAb Absolute low alarm
- [24] AL1t = HiAb Absolute high alarm
- [24] AL1t = LodE Deviation low alarm (relative)
- [24] AL1t = LidE Deviation high alarm (relative)

**Range:** from [26] AL1L to [27] AL1H engineering units.

**[29] HAL1 - Alarm 1 hysteresis**

**Available:** when [24] AL1t is different to “nonE”

**Range:** from 1 to 9999 engineering units

**Notes:**

- The hysteresis value is the difference between the Alarm threshold value and the point the Alarm automatically resets.
- When the alarm threshold plus or minus the hysteresis is out of input range, the instrument will not be able to

reset the alarm.

Example: Input range from 0 to 1000 (mBar).

- set point equal to 900 (mBar)
- deviation low alarm equal to 50 (mBar)
- Hysteresis equal to 160 (mBar)

the theoretical reset point is  $900 - 50 + 160 = 1010$  (mBar) but this value is out of range.

The reset can be made only by turning the instrument OFF, removing the condition that generate the alarm and then turn the instrument ON again.

- All band alarms use the same hysteresis value for both thresholds.
- When the hysteresis of a band alarm is bigger than the programmed band, the instrument will not be able to reset the alarm.

Example: Input range from 0 to 500 (°C).

- set point equal to 250 (°C)
- relative band alarm
- Low threshold equal to 10 (°C)
- High threshold equal to 10 (°C)
- Hysteresis equal to 25 (°C)

### [30] AL1d – Alarm 1 delay

**Available:** when [24] AL1t different form “nonE”

**Range:** from OFF (0) to 9999 seconds

**Note:** The alarm goes ON only when the alarm condition persists for a time longer than [30] AL1d time but the reset is immediate.

### [31] AL1o - Alarm 1 enabling during Stand-by mode

**Available:** when [24] AL1t different from “nonE”

**Range:**

- no = alarm 1 disabled during Stand by mode
- YES = alarm 1 enabled during Stand by mode

## 1 AL2 Group - Alarm 2 parameters

### [32] AL2t - Alarm 2 type

**Available:** Always

**Range:**

When one or more outputs are programmed as control output

- nonE = Alarm not used
- LoAb = Absolute low alarm
- HiAb = Absolute high alarm
- LHAb = Absolute band alarm
- LodE = Deviation low alarm (relative)
- HiDE = Deviation high alarm (relative)
- LHdE = Relative band alarm.

When no output is programmed as control output

- nonE = Alarm not used
- LoAb = Absolute low alarm
- HiAb = Absolute high alarm
- LHAb = Absolute band alarm

**Notes:** The relative alarm are “relative” to the current set point (this may be different to the Target setpoint if you are using the ramp to set point function).

### [33] Ab2 – Alarm 2 function

**Available:** when [32] AL2t is different from “nonE”

**Range:** 0 to 15 with the following rule:

- +1 = Not active at power up.
- +2 = Latched alarm (manual reset)
- +4 = Acknowledgeable alarm
- +8 = Relative alarm not active at set point change

Example: setting Ad2 equal to 5 (1+4) the alarm 2 will be “not active at power up” and “Acknowledgeable”.

**Notes:** For other details see [25] Ab1 parameter.

### [34] AL2L - For High and low alarms, it is the low limit of the AL2 threshold

- For band alarm, it is low alarm threshold

**Available:** when [32] AL2t is different from “nonE”

**Range:** from - 1999 to [35] AL2H engineering units.

### [35] AL2H - For High and low alarms, it is the high limit of the AL2 threshold

- For band alarm, it is high alarm threshold

**Available:** when [32] AL2t is different from “nonE”

**Range:** from [34] AL2L to 9999 engineering units.

### [36] AL2 - Alarm 2 threshold

**Available:** when

- [32] AL2t = LoAb Absolute low alarm
- [32] AL2t = HiAb Absolute high alarm
- [32] AL2t = LodE Deviation low alarm (relative)
- [32] AL2t = LidE Deviation high alarm (relative)

**Range:** from [34] AL2L to [35] AL2H engineering units.

### [37] HAL2 - Alarm 2 hysteresis

**Available:** when [32] AL2t is different to “nonE”

**Range:** from 1 to 9999 engineering units

**Notes:** for other details see [29] HAL1 parameter

### [38] AL2d – Alarm 2 delay

**Available:** when [32] AL2t different form “nonE”

**Range:** from OFF (0) to 9999 seconds

**Note:** The alarm goes ON only when the alarm condition persist for a time longer than [38] AL2d time but the reset is immediate.

### [39] AL2o - Alarm 2 enabling during Stand-by mode

**Available:** when [32] AL2t different from “nonE”

**Range:**

- no = alarm 2 disabled during Stand by mode
- YES = alarm 2 enabled during Stand by mode

## 1 AL3 Group - Alarm 3 parameters

### [40] AL3t - Alarm 3 type

**Available:** Always

**Range:**

When one or more outputs are programmed as control

output

- nonE = Alarm not used
- LoAb = Absolute low alarm
- HiAb = Absolute high alarm
- LHAb = Absolute band alarm
- LodE = Deviation low alarm (relative)
- HidE = Deviation high alarm (relative)
- LHdE = Relative band alarm.

When no output is programmed as control output

- nonE = Alarm not used
- LoAb = Absolute low alarm
- HiAb = Absolute high alarm
- LHAb = Absolute band alarm

**Notes:** The relative alarm are “relative” to the current set point (this may be different to the Target setpoint if you are using the ramp to set point function).

#### [41] Ab3 – Alarm 3 function

**Available:** when [40] AL3t is different from “nonE”

**Range:** 0 to 15 with the following rule:

- +1 = Not active at power up.
- +2 = Latched alarm (manual reset)
- +4 = Acknowledgeable alarm
- +8 = Relative alarm not active at set point change

Example: setting Ad3 equal to 5 (1+4) the alarm 3 will be “not active at power up” and “Acknowledgeable”.

**Notes:** For other details see [25] Ab1 parameter.

#### [42] AL3L - For High and low alarms, it is the low limit of the AL3 threshold - For band alarm, it is low alarm threshold

**Available:** when [40] AL3t is different from “nonE”

**Range:** from - 1999 to [43] AL3H engineering units.

#### [43] AL3H - For High and low alarms, it is the high limit of the AL3 threshold - For band alarm, it is high alarm threshold

**Available:** when [40] AL3t is different from “nonE”

**Range:** from [42] AL3L to 9999 engineering units.

#### [44] AL3 - Alarm 3 threshold

**Available:** when

- [40] AL3t = LoAb Absolute low alarm
- [40] AL3t = HiAb Absolute high alarm
- [40] AL3t = LodE Deviation low alarm (relative)
- [40] AL3t = LidE Deviation high alarm (relative)

**Range:** from [42] AL3L to [43] AL3H engineering units.

#### [45] HAL3 - Alarm 3 hysteresis

**Available:** when [40] AL3t is different to “nonE”

**Range:** from 1 to 9999 engineering units

**Notes:** for other details see [29] HAL1 parameter

#### [46] AL3d – Alarm 3 delay

**Available:** when [40] AL3t different form “nonE”

**Range:** from oFF (0) to 9999 seconds

**Note:** The alarm goes ON only when the alarm condition persist for a time longer than [46] AL3d time but the reset is immediate.

#### [47] AL3o - Alarm 3 enabling during Stand-by mode

**Available:** when [40] AL3t different from “nonE”

**Range:**

- no = alarm 3 disabled during Stand by mode
- YES = alarm 3 enabled during Stand by mode.

### ] LbA group - Loop break alarm

#### General note about LBA alarm

The LBA operate as follows:

When you apply 100 % of the power output to a process, the process variable, after a time due to the process inertia, begins to change in a known direction (increases for an heating action or decreases for a cooling action).

Example: if I apply 100% of the power output to a furnace, the temperature must go up unless one of the component in the loop is faulty (heater, sensor, power supply, fuse, etc...)

The same philosophy can be applied to the minimum power. In our example, when I turn OFF the power to a furnaces, the temperature must go down, if not the SSR is in short circuit, the valve is jammed, etc..

LBA function is automatically enabled when the PID requires the maximum or the minimum power. When the process response is slower than the programmed limit the instrument generates an alarm.

**NOTES:**

- When the instrument is in manual mode, the LBA function is disabled.
- When LBA alarm is ON the instrument continue to perform the standard control. If the process response come back into the programmed limit, the instrument reset automatically the LBA alarm.
- This function is available only when the programmed control algorithm is equal to PID (Cont = PID).

#### [48] LbAt - LBA time

**Available:** when [52] Cont = PID

**Range:** oFF = LBA not used or from 1 to 9999 seconds

#### [49] LbSt – Delta measure used by LBA during Soft start

**Available:** when [48] LbAt is different from oFF

**Range:**

- oFF = loop break alarm is inhibit during soft start
- 1 to 9999 engineering units.

#### [50] LbAS – Delta measure used by loop break alarm (loop break alarm step)

**Available:** when [48] LbAt is different from oFF

**Range:** from 1 to 9999 engineering units.

**[51] LbcA - Condition for LBA enabling**

**Available:** when [48] LbAt is different from off

**Range:**

- uP = Enabled when the PID requires the maximum power only.
- dn = Enabled when the PID requires the minimum power only
- both = Enabled in both condition (when the PID requires the maximum or the minimum power).

**LBA application example:**

LbAt (LBA time) = 120 seconds (2 minutes)

LbAS (delta LBA) = 5 °C

The machine has been designed in order to reach 200 °C in 20 minutes (20°C/min).

When the PID demand 100 % power, the instrument starts the time count.

During time count if the measured value increases more than 5 °C, the instrument restarts the time count. Otherwise if the measured value does not reach the programmed delta (5 °C in 2 minutes) the instrument will generate the alarm.

**rEG group - Control parameters**

The rEG group will be available only when at least one output is programmed as control output (H.rEG or C.rEG).

**[52] cont - Control type:**

**Available:** when at least one output is programmed as control output (H.rEG or C.rEG).

**Range:**

When two control action (heat **and** cool) are programmed:

- Pid = PID (heat **and** cool)
- nr = Heat/Cool ON/OFF control with neutral zone

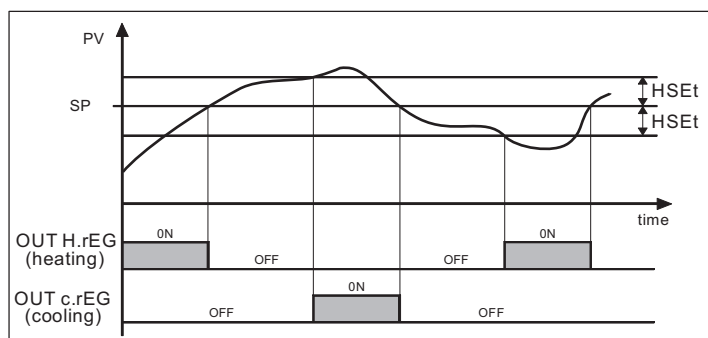

When one control action (heat **or** cool) is programmed:

- Pid = PID (heat **or** cool)
- On.FA = ON/OFF asymmetric hysteresis
- On.FS = ON/OFF symmetric hysteresis

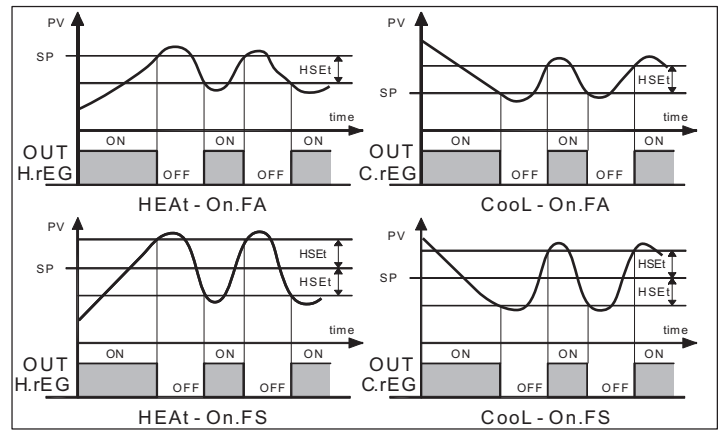

**Note:**

- ON/OFF control with asymmetric hysteresis :
  - OFF when PV ≥ SP
  - ON when PV ≤ (SP - hysteresis)
- ON/OFF control with symmetric hysteresis :
  - OFF when PV ≥ (SP + hysteresis)
  - ON when PV ≤ (SP - hysteresis)

**[53] Auto – Auto tune selection**

Tecnologic has developed two auto-tune algorithms:

- 1) Oscillating auto-tune:
- 2) Fast auto-tune

- 1) The oscillating auto-tune is the usual auto-tune and:
  - it is more accurate
  - can start even if PV is close to the set point.
  - can be used even if the set point is close to the ambient temperature.
- 2) The fast type is suitable when:
  - The process is very slow and you want to be operative in a short time.
  - When an high overshoot is not acceptable.
  - In multi loop machinery where the fast method reduces the calculation error due to the effect of the other loops.

**NOTE:** fast auto-tune can start only when the measured value (PV) is lower than (SP + 1/2SP).

**Available:** when [49] cont = PID

Range: from -4 to 4

where:

- 4 = Oscillating auto-tune with automatic restart at power up (after soft start) and after **all** set point change.
- 3 = Oscillating auto-tune with manual start.
- 2 = Oscillating auto-tune with automatic start at the first power up only.
- 1 = Oscillating auto-tune with automatic restart at every power up
- 0 = Not used
- 1 = Fast auto tuning with automatic restart at every power up
- 2 = Fast auto-tune with automatic start at the first power up only.

- 3 = FAST auto-tune with manual start
- 4 = FAST auto-tune with automatic restart at power up (after soft start) and after a set point change.

**NOTE:** The auto-tune is inhibited during program execution.

**[54] Aut.r - Manual start of the auto-tune**

**Available:** when [52] cont = PID

**Range:**

- oFF = the instrument is not performing the auto-tune
- on = the instrument is performing the auto-tune

**[55] SELF - Self-tune enable**

The self-tuning is an adaptive algorithm able to optimize continuously the PID parameter value.

This algorithm is specifically designed for all process subjected to big load variation able to change heavily the process response.

**Available:** when [52] cont = PID

**Range:**

- oFF = the instrument is **not** performing the self-tune
- on = the instrument is performing the self-tune

**[56] HSEt - Hysteresis of the ON/OFF control**

**Available:** when [52] cont is different from PID.

**Range:** from 0 to 9999 engineering units.

**[57] cPdt – Time for compressor protection**

**Available:** when [52] cont = nr

**Range:**

- OFF = protection disabled
- From 1 to 9999 seconds.

**[58] Pb - Proportional band**

**Available:** When [52] cont = PID and [55] SELF = no

**Range:** from 1 to 9999 engineering units.

**Note:** auto-tune functions calculate this value.

**[59] int - Integral time**

**Available:** When [52] cont = PID and [55] SELF = no

**Range:**

- OFF = Integral action excluded
- from 1 to 9999 seconds
- inF= Integral action excluded

**Note:** auto-tune functions calculate this value.

**[60] dEr - Derivative time**

**Available:** When [52] cont = PID and [55] SELF = no

**Range:**

- oFF - derivative action excluded
- from 1 to 9999 seconds

**Note:** auto-tune functions calculate this value.

**[61] Fuoc - Fuzzy overshoot control**

This parameter reduces the overshoot usually present at instrument start up or after a set point change and it will be active only in this two cases.

Setting a value between 0.00 and 1.00 it is possible to slow down the instrument action during set point approach. Setting Fuoc = 1 this function is disabled

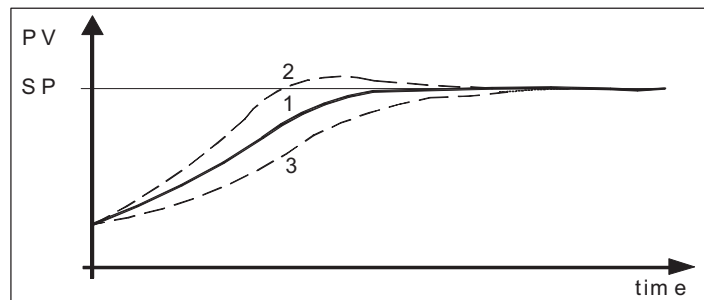

**Available:** When [49] cont = PID and [52] SELF = no

**Range:** from 0 to 2.00.

**Note:** fast auto-tune calculates the Fuoc parameter while the oscillating one sets it equal to 0.5.

**[62] H.Act – Heating output (H.rEG) actuator**

This parameter sets the minimum cycle time of the heating output calculated by the auto-tune algorithm. It aims to respect the minimum cycle time of a specific actuator in order to assure a long actuator life.

**Available:** When at list one output is programmed in order to be the heating output (H.rEG), [52] cont = PID and [55] SELF = no

**Range:**

- SSr = Solid state relay output
- rELY = Relay or contactor
- SLou = Slow actuator (e.g. burners)

**Note:** setting

- SSr no limit is applied to the auto-tune calculation and [63] tcrH is pre-set equal to 1 seconds
- rELY the limit applied to the auto-tune calculation is equal to 20 seconds and [63] tcrH is pre-set equal to 20 seconds
- SLou the limit applied to the auto-tune calculation is equal to 40 seconds and [63] tcrH is pre-set equal to 40 seconds

**[63] tcrH - Cycle time of the heating output**

**Available:** When at least one output is programmed in order to be the heating output (H.rEG), [52] cont = PID and [55] SELF = no

**Range:**

- when [62] H.Act = SSr from 1.0 to 130.0 seconds
- when [62] H.Act = rELY from 20,0 to 130.0 seconds
- when [62] H.Act = SLou from 40,0 to 130.0 second

**Note:** auto-tune functions calculate this value but, when necessary, it is possible to set it manually

**[64] PrAt - Power ratio between heating and cooling**

### action (relative cooling gain)

The instrument uses the same PID parameter set for heat and for cool action but the efficiency of the two actions are usually different.

This parameter allows to define the ratio between the efficiency of the heating system and the efficiency of the cooling one.

An example will help us to explain you the philosophy. Consider one loop of a plastic extruder.

The working temperature is equal to 250 °C.

When you want to increase the temperature from 250 to 270 °C (delta 20 °C) using 100% of the heating power (resistor), you will need 60 seconds.

On the contrary, when you want to decrease the temperature from 250 to 230 °C (delta 20 °C) using 100% of the cooling power (fan), you will need 20 seconds only. In our example the ratio is equal to  $60/20 = 3$  ([60] PrAt = 3) and it says that the efficiency of the cooling system is 3 times more efficient of the heating one.

**Available:** When two control actions are programmed (H.rEG and c.rEG) and [52] cont = PID and [55] SELF = no

**Range:** from 0.01 to 99.99

**Note:** auto-tune functions calculate this value.

### [65] c.Act – Cooling output (C.rEG) actuator

**Available:** When at list one output is programmed in order to be the cooling output (c.rEG), [52] cont = PID and [55] SELF = no

**Range:**

SSr = Solid state relay output

rELY. = Relay or contactor

SLou = Slow actuator (e.g. compressors)

**Note:** for more details see [62] h.Act parameter

### [66] tcrc - Cycle time of the cooling output

**Available:** When at least one output is programmed in order to be the cooling output (c.rEG), [52] cont = PID and [55] SELF = no

**Range:**

when [62] H.Act = SSr

from 1.0 to 130.0 seconds

when [62] H.Act = rELY

from 20.0 to 130.0 seconds

when [62] H.Act = SLou

from 40.0 to 130.0 second

**Note:** auto-tune functions calculate this value.

### [67] rS - Manual reset (integral pre-load)

It allows to drastically reduce the undershoot due to a hot restart.

When your process is steady, the instrument operates with a steady power output (e.g. 30%).

If a short power down occurs, the process restarts with a process variable close to the set point while the instrument starts with an integral action equal to zero.

Setting a manual reset equal to the average power output (in our example 30 %) the instrument will start with a power output equal to the value it will use at

steady state (instead of zero) and the undershoot will become very little (in theory equal to zero).

**Available:** When [52] cont = PID and [55] SELF = no

**Range:** from -100.0 to 100.0 %

### [68] od – Delay at power up

**Available:** When at list one output is programmed as control output.

**Range:**

- oFF : Function not used

- from 0.01 to 99.59 hh.mm

**Notes:**

- This parameter defines the time during which (after a power up) the instrument remains in stand by mode before to start all other function (control, alarms, program, etc.)
- When a program with automatic start at power up and od function are programmed, the instrument performs od function before to start the program execution.
- When an auto-tune with automatic start at power up and od function are programmed, the od function will be aborted and auto-tune will start immediately.

### [69] St.P - Maximum power output used during soft start

**Available:** When at list one output is programmed as control output.

**Range:** from -100 to 100 %

**Notes:**

- When St.P parameter have a **positive** value, the limit will be applied to the **heating** output(s) only.
- When St.P parameter have a **negative** value, the limit will be applied to the **cooling** output(s) only.
- When a program with automatic start at power up and soft start function are programmed, the instrument performs both functions at the same time. In other words, the program performs the first ramp, while the requested power is lower than the limit the instrument operates as usual, when the PID requires more than the limit the power output will be limited.
- The auto-tune function inhibits the soft start function.
- The Soft start function is available also when ON/OFF control is used

### [70] SSt - Soft start time

**Available:** When at list one output is programmed as control output.

**Range:**

- oFF : Function not used

- from 0.01 to 7.59 hh.mm

- inF : soft start always active

### [71] SS.tH – Threshold for soft start disabling

**Available:** When at list one output is programmed as control output.

**Range:** from -1999 to 9999 engineering units

**Note:**

- When the power limiter have a **positive** value (the limit



is applied to the **heating** action) the soft start function will be aborted when the measured value is **greater** or equal to SS.tH parameter.

- When the power limiter have a **negative** value (the limit is applied to the **cooling** action) the soft start function will be aborted when the measured value is **lower** or equal to SS.tH parameter.

## 1 SP Group - Set point parameters

**The SP group will be available only when at least one output is programmed as control output (H.rEG or C.rEG).**

### [72] nSP – Number of used set points

**Available:** When at least one output is programmed as control output.

**Range:** from 1 to 4

**Note:** When you change the value of this parameter, the instrument operates as follows:

- [79] SPAt parameter will be forced to SP1.
- The instrument verifies that all used set point are within the limits programmed by [73] SPLL end [74] SPHL. If an SP is out of this range, the instrument forces it to the maximum acceptable value

### [73] SPLL - Minimum set point value

**Available:** When at least one output is programmed as control output.

**Range:** from -1999 to [74] SPHL engineering units

**Notes:**

- When you change the [73] SPLL value, the instrument checks all local set points (SP1, SP2, SP3 and SP4 parameters) and all set points of the program ([94] Pr.S1, [99] Pr.S2, [104] Pr.S3, [109] Pr.S4 parameters). If an SP is out of this range, the instrument forces it to the maximum acceptable value
- A [73] SPLL change produces the following actions
  - when [80] SP.rt = SP the remote set point will be forced to be equal to the active set point
  - When [80] SP.rt = trim the remote set point will be forced to zero
  - When [80] SP.rt = PErc the remote set point will be forced to zero

### [74] SPHL - Maximum set point value

**Available:** When at least one output is programmed as control output.

**Range:** from [73] SPLL to 9999 engineering units

**Note:** for other details see [73] SPLL parameter.

### [75] SP 1 - Set Point 1

**Available:** When at least one output is programmed as control output.

**Range:** from [73] SPLL to [74] SPHL engineering units

### [76] SP 2 - Set Point 2

**Available:** When at least one output is programmed as

control output and [72] nSP > 1.

**Range:** from [73] SPLL to [74] SPHL engineering units

### [77] SP 3 - Set Point 3

**Available:** When at least one output is programmed as control output and [72] nSP > 2.

### [78] SP 4 - Set Point 4

**Available:** When at least one output is programmed as control output and [72] nSP =4.

**Range:** from [73] SPLL to [74] SPHL engineering units

### [79] SPAt - Selection of the active Set point

**Available:** When at least one output is programmed as control output.

**Range:** from "SP1" to [72] nSP.

**Notes:**

- A [75] SPAt change produces the following actions
  - when [80] SP.rt = SP - the remote set point will be forced to be equal to the active set point
  - When [80] SP.rt = trin - the remote set point will be forced to zero
  - When [80] SP.rt = PErc - the remote set point will be forced to zero
- SP2, SP3 and SP4 selection will be shown only the relative set point is enabled (see [75] nSP parameter).

### [80] SP.rt – Remote set point type

These instrument will communicate with each other, using RS 485 seroial interface without a PC. An instrument can be set as a Master while the other are (as usual) Slave units. The Master unit can send his operative set point to the slave units.

In this way, for example, it is possible to change simultaneously the set point of 20 instruments by changing the set point of the master unit (e.g. hot runner application).

SP.rt parameter defines how the slaves units will use the value coming from serial link.

The [125] tr.SP (Selection of the value to be retransmitted (Master)) parameter allows to define the value sent by master unit.

**Available:** When at least one output is e programmed as control output and the serial interface is present.

**Range:**

- rSP = The value coming from serial link is used as remote set point (RSP).
- trin = The value coming from serial link will be algebraically added to the local set point selected by SPAt and the sum becomes the operative set point
- PErc = The value coming from serial will be scaled on the input range and this value will be used as remote set point.

**Note:**

- A [80] SPrt change produces the following actions
  - when [80] SP.rt = rSP - the remote set point will be forced to be equal to the active set point

- When [80] SP.rt = trin - the remote set point will be forced to zero
- When [80] SP.rt = PErc - the remote set point will be forced to zero

Example:

A 6 zone reflow-oven for PCB .

The master unit sends its set point value to 5 other zones (slave controllers).

The Slave zones use it as a set point trim.

The first zone is the master zone and it uses a set point equal to 210 °C.

The second zone has a local set point equal to - 45 °C

The third zone has a local set point equal to -45 (°C)

The fourth zone has a local set point equal to -30

The fifth zone has a local set point equal to +40

The sixth zone has a local set point equal to +50

In this way, the thermal profile will be the following:

- master SP = 210 °C
- second zone SP = 210 -45 = 165 °C
- third zone SP = 210 -45 = 165 °C
- fourth zone SP = 210 - 30 = 180 °C
- fifth zone SP = 210 + 40 = 250 °C
- sixth zone SP = 210 + 50 = 260 °C

Changing the SP of the master unit, all the other slave units will immediately change their operative set point.

### [81] SPLr – Local/remote set point selection

**Available:** When at list one output is programmed as control output.

**Range:**

- Loc = local set point selected by [79] SPAt
- rEn = Remote set point (coming from serial link)

### [82] SP.u - Rate of rise for positive set point change (ramp up)

**Available:** When at list one output is e programmed as control output.

**Range:**

- 0.01 ÷ 99.99 units per minute
- inF = ramp disabled (step transfer)

### [83] SP.d - Rate of rise for negative set point change (ramp down)

**Available:** When at list one output is e programmed as control output.

**Range:**

- 0.01 ÷ 99.99 units per minute
- inF = ramp disabled (step transfer)

**General note about remote set point:** when the remote set point (RSP) with trim action is programmed, the local set point range becomes the following: from [73] SPLL+ RSP to [74] SPHL - RSP

### ] tin group - Timer function parameters

Five timer types are available:

Delayed start with a delay time and a “end of cycle” time

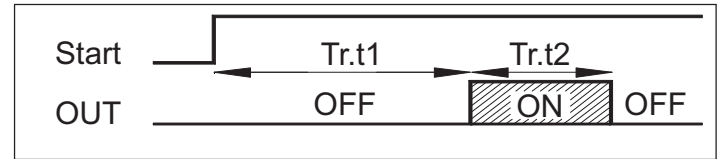

- Setting tr.t2 = Inf the timer out remains in ON condition until a reset command is detected.

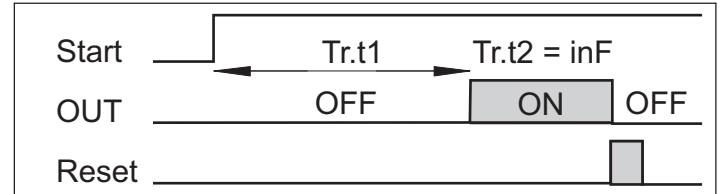

Delayed start at power up with a delay time and a “end of cycle” time

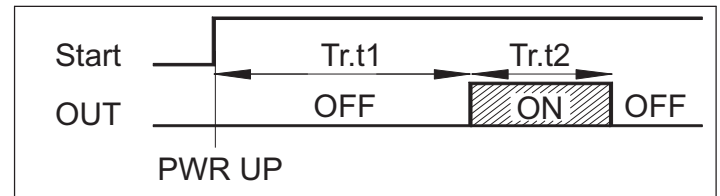

Feed-through

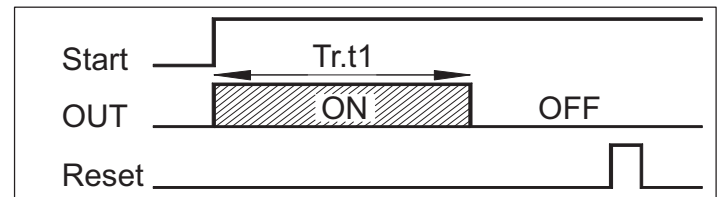

Asymmetrical oscillator with start in OFF

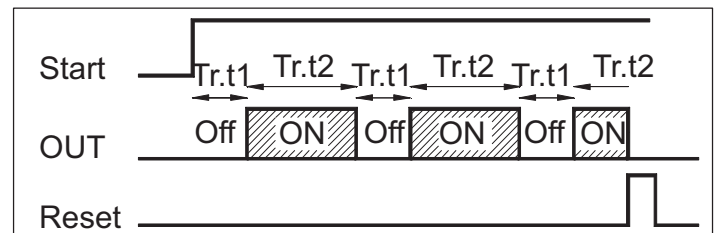

Asymmetrical oscillator with start in ON

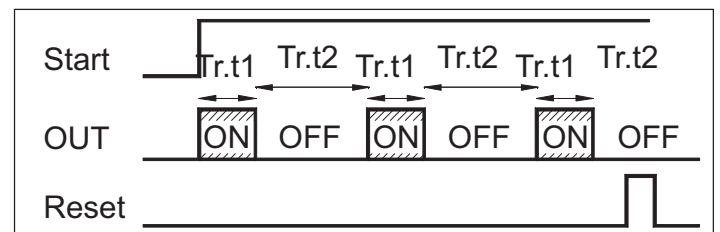

**NOTES:**

- The instrument can receive the start, hold and reset commands by U button, by logic inputs and/or by serial link

- An HOLD command can suspend the time count.

#### [84] t.F= Independent timer function

**Available:** Always

**Range:**

- nonE = Timer not used
- i.d.A = Delayed start timer
- i.u.P.d = Delayed start at power up
- i.d.d = Feed-through timer
- i.P.L = Asymmetrical oscillator with start in OFF
- i.L.P = Asymmetrical oscillator with start in ON

#### [85] tr.u – Engineering unit of the time

**Available:** when [84] Tr.F is different form nonE

**Range:**

- hh.nn = Hours and minutes
- nn.SS = Minutes and seconds
- SSS.d = Seconds and tenth of seconds

**Note:** when the timer is running, you can see the value of this parameter but you can NOT modify it.

#### [86] tr.t1 – Time 1

**Available:** when [84] Tr.F is different form nonE

**Range:**

- when [85] tr.u = hh.nn from 00.01 to 99.59
- when [85] tr.u = nn.SS from 00.01 to 99.59
- when [85] tr.u = SSS.d from 000.1 to 995.9

#### [87] tr.t2 – Time 2

**Available:** when [84] Tr.F is different form nonE

**Range:**

- when [85] tr.u = hh.nn from 00.01 to 99.59 + inF
- when [85] tr.u = nn.SS from 00.01 to 99.59 + inF
- when [85] tr.u = SSS.d from 000.1 to 995.9 + inF

**Note:** Setting [87] tr.t2 = inF, the second time can be stopped by a reset command only.

#### [88] tr.St – Timer status

**Available:** when [84] Tr.F is different form nonE

**Range:**

- run = Timer Run
- HoLd = Timer Hold
- rES = Timer reset

**Note:** this parameter allows to manage timer execution by a parameter (without digital inputs or U button).

### PrG Group - Programmer function parameter

These instruments are able to perform a set point profile compounded of 4 groups of 2 steps (8 step total).

The first step is a ramp (used to reach the desired set point), the second is a soak (on the desired set point).

When a RUN command is detected the instrument aligns the operative set point to the measured value and starts to execute the first ramp.

In addition, each soak is equipped with a wait band which suspends the time count when the measured

value goes out of the defined band (guaranteed soak). Moreover, for each segment it is possible to define the status of two events. An event can drive an output and make an action during one or more specific program steps. Some additional parameters allow to define the time scale, the automatic RUN conditions and the instrument behaviour at the end of the program.

**NOTES:**

1) all steps can be modified during program execution.

2) During program execution the instrument memorize the segment currently in use and, by a 30 minutes interval, it memorize also the elapsed time of the soaks.

If a power down occurs during program execution, at the next power up the instrument is able to continue the program execution starting from the segment in progress at power down and, if the segment was a soak, it is also capable to restart from the soak time minus the elapsed time memorized.

In order to obtain this features, the “[120]dSPu - Status of the instrument at power u” parameter must be set to “AS.Pr”.

If the “[120]dSPu” parameter is different from “AS.Pr” The memorization function will be inhibited.

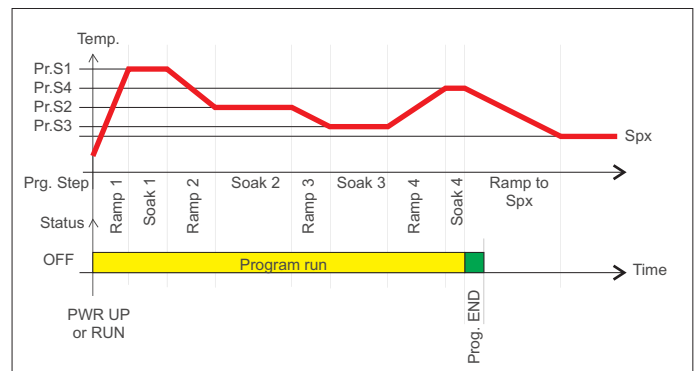

#### [89] Pr.F = Programmer action at power up

**Available:** Always

**Range:**

- nonE = Program not used
- S.u.P.d = Start at power up with a first step in stand by
- S.u.P.S = Start at power up
- u.diG = Start at RUN command detection only
- U.dG.d = Start at RUN command detection with a first step in stand by

#### [90] Pr.u – Engineering units of the soaks

**Available:** when [89] Pr.F is different from nonE

**Range:**

- hh.nn = Hours and minutes
- nn.SS = Minutes and seconds

**Note:** during program execution, this parameter can not be modified.

#### [91] Pr.E – Instrument behaviour at the End of the

**program execution.**

**Available:** when [89] Pr.F is different from nonE

**Range:**

- cnt = continue (the instrument will use the set point of the last soak until a reset command is detected)
- SPAt = go to the set point selected by [79] SPAt parameter
- St.bY = Go in stand by mode.

**Note:**

- Setting [91] Pr.E = cnt the instrument operates as follows: at program end, it will use the set point of the last soak. When a reset command is detected, it goes to the set point selected by [79] SPAt parameter. The transfer will be a step transfer or a ramp according to the [82] SP.u (Maximum rate of rise for positive set point change) and [83] SPd (Maximum rate of rise for negative set point change).
- Setting [91] Pr.E = SPAt the instrument goes immediately to the set point selected by [79] SPAt parameter. The transfer will be a step transfer or a ramp according to the [82] SP.u (Maximum rate of rise for positive set point change) and [83] SPd (Maximum rate of rise for negative set point change).

**[92] Pr.Et – Time of the End program indication**

**Available:** when [89] Pr.F is different from nonE

**Range:**

- oFF = Function not used
- from 00.01 to 99.59 minutes and seconds
- inF = indefinitely ON

**Note:**

- Setting [92] Pr.Et = inF the end program indication will go OFF only when a reset command or a new RUN command is detected.

**[93] Pr.S1 - Set point of the first soak**

**Available:** when [89] Pr.F is different from nonE or [89] Pr.F is different from S.uP.d.

**Range:** From [70] SPLL to [71] SPHL

**[94] Pr.G1 – Gradient of the first ramp**

**Available:** when [86] Pr.F is different from nonE or [89] Pr.F is different from S.uP.d.

**Range:**

- From 0.1 ÷ 999.9 eng. units per minute
- inF = Step transfer

**[95] Pr.t1 – Time of the first soak**

**Available:** when [89] Pr.F is different from nonE

**Range:** from 0.00 to 99.59 Time units.

**[96] Pr.b1 – Wait band of the first soak**

**Available:** when [89] Pr.F is different from nonE or [89] Pr.F is different from S.uP.d.

**Range:** from OFF to 9999 engineering units

**Note:** the wait band suspends the time counting when the measured value goes out of the defined band

(guaranteed soak).

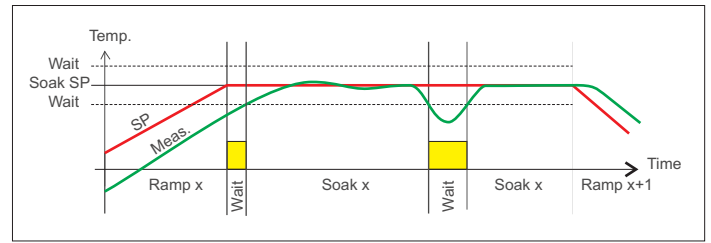

**[97] Pr.E1 – Events of the first group**

**Available:** when [89] Pr.F is different from nonE or [89] Pr.F is different from S.uP.d.

**Range:** from 00.00 to 11.11 where

- 0 = event OFF
- 1 = event ON

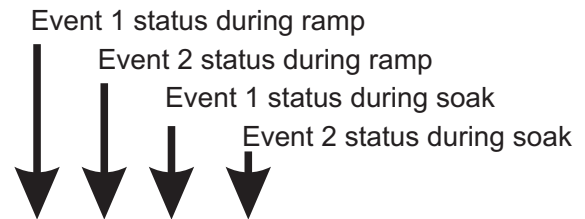

Display	Ramp		Soak	
	Event 1	Event 2	Event 1	Event 2
00.00 =	off	off	off	off
10.00 =	on	off	off	off
01.00 =	off	on	off	off
11.00 =	on	on	off	off
00.10 =	off	off	on	off
10.10 =	on	off	on	off
01.10 =	off	on	on	off
11.10 =	on	on	on	off
00.01 =	off	off	off	on
10.01 =	on	off	off	on
01.01 =	off	on	off	on
11.01 =	on	on	off	on
00.11 =	off	off	on	on
10.11 =	on	off	on	on
01.11 =	off	on	on	on
11.11 =	on	on	on	on

**[98] Pr.S2 - Set point of the second soak**

**Available:** when [89] Pr.F is different from nonE

**Range:**

- from [73] SPLL to [74] SPHL
- oFF = program end

**Note:** It is not necessary to configure all steps.

When you use for example 2 groups only, it is sufficient to set the set point of the third group equal to OFF. The instrument will mask all the following parameters of the

programmer.

#### **[99] Pr.G2 – Gradient of the second ramp**

**Available:** when [89] Pr.F is different from nonE and [98] Pr.S2 is different from oFF

**Range:**

- From 0.1 ÷ 999.9 eng. units per minute
- inF = Step transfer

#### **[100] Pr.t2 – Time of the second soak**

**Available:** when [89] Pr.F is different from nonE and [98] Pr.S2 is different from oFF

**Range:** from 0.00 to 99.59 time units

#### **[101] Pr.b2 – Wait band of the second soak**

**Available:** when [89] Pr.F is different from nonE and [98] Pr.S2 is different from oFF

**Range:** from OFF to 9999 engineering units

**Note:** for more details see [96]Pr.b1 parameter

#### **[102] Pr.E2 – Events of the second group**

**Available:** when [89] Pr.F is different from nonE and [98] Pr.S2 is different from oFF

**Range:** from 00.00 to 11.11 where

- 0 = event OFF
- 1 = event ON

**Note:** for more details see [97]Pr.E1 parameter.

#### **[103] Pr.S3 - Set point of the third soak**

**Available:** when [89] Pr.F is different from nonE and [98] Pr.S2 is different from oFF

**Range:**

- from [73] SPLL to [74] SPHL
- oFF = program end

**Note:** for more details see [98]Pr.S2 parameter.

#### **[104] Pr.G3 – Gradient of the third ramp**

**Available:** when [89] Pr.F is different from nonE, [98] Pr.S2 is different from oFF and [103] Pr.S3 is different from OFF.

**Range:**

- From 0.1 ÷ 999.9 eng. units per minute
- inF = Step transfer

#### **[105] Pr.t3 – Time of the third soak**

**Available:** when [89] Pr.F is different from nonE, [98] Pr.S2 is different from oFF and [103] Pr.S3 is different from OFF.

**Range:** from 0.00 to 99.59 time units.

#### **[106] Pr.b3 – Wait band of the third soak**

**Available:** when [89] Pr.F is different from nonE, [98] Pr.S2 is different from oFF and [103] Pr.S3 is different from OFF.

**Range:** from OFF to 9999 engineering units

**Note:** for more details see [96]Pr.b1 parameter

#### **[107] Pr.E3 – Events of the third group**

**Available:** when [89] Pr.F is different from nonE, [98] Pr.S2 is different from oFF and [103] Pr.S3 is different from OFF.

**Range:** from 00.00 to 11.11 where

- 0 = event OFF
- 1 = event ON

**Note:** for more details see [97]Pr.E1 parameter.

#### **[108] Pr.S4 - Set point of the fourth soak**

**Available:** when [89] Pr.F is different from nonE, [98] Pr.S2 is different from oFF and [103] Pr.S3 is different from OFF.

**Range:**

- from [73] SPLL to [74] SPHL
- oFF = program end

**Note:** for more details see [98]Pr.S2 parameter.

#### **[109] Pr.G4 – Gradient of the fourth ramp**

**Available:** when [89] Pr.F is different from nonE, [98] Pr.S2 is different from oFF, [103] Pr.S3 is different from OFF and [108] Pr.S4 is different from OFF

**Range:**

- From 0.1 ÷ 999.9 eng. units per minute
- inF = Step transfer

#### **[110] Pr.t4 – Time of the fourth soak**

**Available:** when [89] Pr.F is different from nonE, [98] Pr.S2 is different from oFF, [103] Pr.S3 is different from OFF and [108] Pr.S4 is different from OFF

**Range:** from 0.00 to 99.59 time units.

#### **[111] Pr.b4 – Wait band of the fourth soak**

**Available:** when [89] Pr.F is different from nonE, [98] Pr.S2 is different from oFF, [103] Pr.S3 is different from OFF and [108] Pr.S4 is different from OFF

**Range:** from OFF to 9999 engineering units

**Note:** for more details see [96]Pr.b1 parameter

#### **[112] Pr.E4 – Event of the fourth segment**

**Available:** when [89] Pr.F is different from nonE, [98] Pr.S2 is different from oFF, [103] Pr.S3 is different from OFF and [108] Pr.S4 is different from OFF

**Range:** from 00.00 to 11.11 where

- 0 = event OFF
- 1 = event ON

**Note:** for more details see [97]Pr.E1 parameter.

#### **[113] Pr.St – Program status**

**Available:** when [89] Pr.F is different from nonE

**Range:**

- run = Program Run
- HoLd = Program Hold
- rES = Program reset

**Note:** this parameter allows to manage program execution by a parameter.

## “ ] PAn” group - Operator HMI

### [114] PAS2 – Level 2 password: Limited access level

**Available:** Always

**Range:**

- oFF = Level 2 not protected by password (as level 1 = Operator level).
- from 1 to 999.

### [115] PAS3 – Level 3 password : configuration level

**Available:** Always

**Range:** from 3 to 999.

**Note: Setting** [114] PAS2 equal to [115] PAS3, the level 2 will be masked.

### [116] uSrb - U button function during RUN TIME

**Available:** ever

**Range:**

- nonE = No function
- tunE = Auto-tune/self-tune enabling  
A single press (longer than 1 second) starts the auto-tune .
- oPLo = Manual mode.  
The first pressure puts the instrument in manual mode (OPLO) while a second one puts the instrument in Auto mode.
- AAc = Alarm reset
- ASi = Alarm acknowledge
- chSP = Sequential set point selection  
(see note below).
- St.by = Stand by mode  
The first press puts the instrument in stand by mode while a second one puts the instrument in Auto mode.
- Str.t = Timer run/hold/reset  
(see note below).
- P.run = Program run  
(see note below).
- P.rES = Program reset.  
(see note below).
- P.r.H.r = Program run/hold/reset  
(see note below).

#### NOTES:

- When “Sequential set point selection” is used, every press of the U button (longer than 1 second) increase the value of SPAT (active set point) of one step.  
The selection is cyclic -> SP1 -> SP2 -> SP3 -> SP4

**Note:** when a new set point is selected using the U key, the display will show for 2 seconds the acronym of the new set point (e.g. SP2).

- When “Sequential set point selection” is used, the number of set points selecteble is limited by [69] nSP.
- When “Timer run/hold/reset” is selected, a short press starts/stops(hold) timer count while a long press (longer than 10 second) resets the timer.
- When “Program run” is selected, the first press starts the program execution but a second press **restarts**

the program execution from the beginning.

- When “Program reset” is selected, a short press allows it to reset the program execution.
- When “Program run/hold/reset” is selected, a short press starts/stop(Hold) program execution while a long press (longer than 10 second) resets the program.

### [117] diSP – Display management

**Available:** Always

**Range:**

- nonE = Standard display
- Pou = Power output
- SPF = Final set point
- Spo = Operative set point
- AL1 = Alarm 1 threshold
- AL2 = Alarm 2 threshold
- AL3 = Alarm 3 threshold
- Pr.tu = - During a soak, the instrument will show the elapsed time of the soak  
- During a ramp the display will show the operative set point.  
At the end of the program execution, the instrument will show “P.End” messages alternately with the measured value.  
- When no program is running, the instrument will show the standard display.
- Pr.td = - During a soak, the instrument will show the remaining time of the soak (count down).  
- During a ramp the display will show the operative set point.  
At the end of the program execution, the instrument will show “P.End” messages alternately with the measured value.  
- When no program is running, the instrument will show the standard display.
- P.t.tu = When the programmer is running, the display will show the total elapsed time.  
At the end of the program execution, the instrument will show “t.End” messages alternately with the measured value.
- P.t.td = When the programmer is running, the display will show the total remaining time (count down).  
At the end of the program execution, the instrument will show “P.End” messages alternately with the measured value.
- ti.uP = When the timer is running, the display will show the timer counting up.  
At the end of the counting, the instrument will show “t.End” messages alternately with the measured value.
- ti.du = When the timer is running, the display will show the timer counting down.  
At the end of the counting, the instrument will show “t.End” messages alternately with the measured value.
- PErc = Percent of the power output used during

soft start (when the soft start time is equal to infinite, the limit is ever active and it can be used also when ON/OFF control is selected)

#### [118] AdE - Bargraph deviation

**Available:** Always

**Range:**

- oFF Bargraph not used
- from 1 to 9999 engineering units

#### [119] FiLd - Filter on the displayed value

**Available:** Always

**Range:**

- oFF Filter disabled
- from 0.1 to 20.0 engineering units.

**Note:**

This is a "window filter" related to the set point; it is applied to the displayed value only and it have no effect on the other functions of the instrument (control, alarms, etc.).

#### [120]dSPu - Status of the instrument at power up

**Available:** Always

**Range:**

- AS.Pr = Starts in the same way it was prior to the power down.
- Auto = Starts in Auto mode
- oP.0 = Starts in manual mode with a power output equal to zero.
- St.bY = Starts in stand-by mode

**NOTES:**

1) when you change the value of [121] oPr.E, the instrument forces [122] oPEr parameter equal to Auto.

2) During program execution the instrument memorize the segment currently in use and, by a 30 minutes interval, it memorize also the elapsed time of the soaks.

If a power down occurs during program execution, at the next power up the instrument is able to continue the program execution starting from the segment in progress at power down and, if the segment was a soak, it is also capable to restart from the soak time minus the elapsed time memorized.

In order to obtain this features, the "[120]dSPu - Status of the instrument at power u" parameter must be set to "AS.Pr".

If the "[120]dSPu" parameter is different from "AS.Pr" The memorization function will be hinibit.

#### [121] oPr.E - Operative modes enabling

**Available:** Always

**Range:**

- ALL = All modes will be selectable by the next parameter.
- Au.oP = Auto and manual (OPLO) mode only will be selectable by the next parameter.
- Au.Sb = Auto and Stand-by modes only will be selectable by the next parameter.

**Note:** when you change the value of [121] oPr.E, the instrument forces [122] oPEr parameter equal to Auto

#### [122] oPEr – Operative mode selection

**Available:** Always

**Range:**

When [121] oPr.E = ALL

- Auto = Auto mode
- oPLo = Manual mode
- St.bY = Stand by mode

When [121] oPr.E = Au.oP

- Auto = Auto mode
- oPLo = Manual mode

When [121] oPr.E = Au.Sb

- Auto = Auto mode
- St.bY = Stand by mode

### ] Ser group - Serial link parameter

#### [123] Add - Instrument address

**Available:** Always

**Range:**

- oFF = Serial interface not used
- from 1 to 254

#### [124] bAud - Baud rate

**Available:** when [123] Add different from oFF

**Range:**

- 1200 = 1200 baud
- 2400 = 2400 baud
- 9600 = 9600 baud
- 19.2 = 19200 baud
- 38.4 = 38400 baud

#### [125] trSP – Selection of the value to be retransmitted (Master)

**Available:** when [123] Add different from oFF

**Range:**

- nonE = Retransmission not used (the instrument is a slave)
- rSP = The instrument become a Master and it retransmits the operative set point.
- PErc = The instrument become a Master and it retransmits the power output.

**Note:** for more details see [80] SP.rt (Remote set point type) parameter.

### ] COn Group - Consumption parameters

#### [126] Co.tY – Measurement type

**Available:** Always

**Range:**

- oFF = Not used
- 1 = Instantaneous power (kW)
- 2 = Power consumption (kW/h)
- 3 = Energy used during program execution.  
This measure starts from zero when a program runs end stops at the end of the program. A new program execution will reset the value.
- 4 = Total worked days with threshold. It is the number of hours that the instrument is turned ON divided for 24.
- 5 = Total worked hours with threshold. It is the number of hours that the instrument is turned ON.

**Note:**

Selections 3 and 4 are an internal counter for machine service inspection intervals. It works every time the instrument is turned ON.

When the count reaches the programmed threshold, the display shows alternately the standard display and the message “r. iSP” (requested Inspection). The count reset can be done only by changing the threshold value.

**[127] UoLt – Nominal Voltage of the load**

**Available:** when [126] Co.tY = ist or [126] Co.tY = h or [126] Co.tY = S.S

**Range:** from 1 to 9999 (V)

**[128] cur – Nominal current of the load**

**Available:** when [126] Co.tY = ist or [126] Co.tY = h or [126] Co.tY = S.S

**Range:** from 1 to 999 (A)

**[129] h.Job – Threshold of the working period**

**Available:** when [126] Co.tY = tot.d or [126] Co.tY = tot.H

**Range:**

- oFF = threshold not used
- from 1 to 999 days or
- from 1 to 999 hours.

**1 CAL group - User calibration group**

This function allows to calibrate the complete measuring chain and to compensate the errors due to:

- Sensor location
- Sensor class (sensor errors)
- Instrument accuracy

**[130] AL.P – Adjust Low Point**

**Available:** Always

**Range:** from -1999 to (AH.P - 10) engineering units

**Note:** the minimum difference between AL.P and AH.P is equal to 10 Engineering Units.

**[131] ALo – Adjust Low Offset**

**Available:** Always

**Range:** from -300 to 300 Engineering Units

**[132] AH.P – Adjust High Point**

**Available:** Always

**Range:** from (AL.P + 10) to 9999 engineering units

**Note:** the minimum difference between AL.P and AH.P is equal to 10 Engineering Units

**[133] AL.o – Adjust Low Offset**

**Available:** Always

**Range:** from -300 to 300 Engineering Units

**Example:** Environmental chamber with an operative range from 10 to + 100 °C.

- 1) Insert in the chamber a reference sensor connected with a reference instrument (usually a calibrator).
- 2) Start the control of the instrument, and set a set point equal to the minimum value of the operative range (e.g. 10 °C)  
When the temperature in the chamber is steady, take note of the temperature measured by the reference system (e.g. 9 °C).
- 3) Set [130] AL.P = 10 (low working point) and [131] ALo = -1 (it is the difference between the reading of the instrument and the reading of the reference system). Note that after this set the measured value of the instrument is equal to the measured value of the reference system.
- 4) Set a set point equal to the maximum value of the operative range (e.g. 100 °C). When the temperature in the chamber is steady, take note of the temperature measured by the reference system (e.g. 98 °C).
- 5) Set [132] AH.P = 100 (low working point) and [133] ALo = +2 (it is the difference between the reading of the instrument and the reading of the reference system). Note that after this set the measured value of the instrument is equal to the measured value of the reference system.

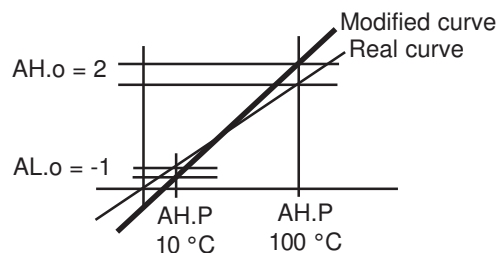

The most important step of the configuration procedure is completed.

In order to exit from configuration parameter procedure, proceed as follows:

- Push U button.
- Push U button for more than 10 seconds
- The instrument will come back to the “standard display”.

**5. PARAMETER PROMOTION**

Another important step of the instrument configuration is due to the possibility to create a custom HMI (interface)



in order to make the instrument easy to use for the operator and comfortable for the assistance. By a special procedure, named promotion, the OEM can create two parameter subsets.

The first one is the "limited access" level. This subset is protected by the password programmed by [114] PAS2 parameter. The last subset is the "Operator" set (Level1). This level is NOT password protected.

**Notes:**

- The "limited access" parameter are collected in a list.
- The sequence of the "limited access" parameters is programmable and can be made according to your needs
- The parameter sequence of the operator level is the same programmed for "limited access" level but only specified parameters can be displayed and modified. This set must be create according to your requirements

**5.1 PARAMETER PROMOTION PROCEDURE**

The limited access parameter set is a list, so that, before to start promotion procedure, we suggest to operate as follows:

- 1) Prepare the exact parameter list you want to make accessible for limited access.
- 2) Number the desired parameters in the same sequence you want to have in the limited access.
- 3) Define which of the selected parameter will be available in Operator level also.

**Example:**

I would like to obtain the following limited access list:

- OPEr - Operative mode selection
- SP1 - first sset point
- SP2 - Second set point
- SPAt - Set point selection
- AL1 - Alarm 1 threshold
- AL2 - Alarm 2 threshold
- Pb - Proportional band
- Int - Integral time
- dEr - Derivative time
- Aut.r - Manual start of the auto-tune

But I want that the operator to be able to change: the operative mode, the SP1 value and the AL1 value.

In this case the promotion will be the following:

Param.	Promotion	Limited Access	Operator
- OPEr -	o 1	OPEr	OPEr
- SP1 -	o 2	SP1	SP1
- SP2 -	A 3	SP2	
- SPAt -	A 4	SPAt	
- AL1 -	o 5	AL1	AL1
- AL2 -	A 6	AL2	
- Pb -	A 7	Pb	
- Int -	A 8	Int	
- dEr -	A 9	dEr	
- Aut.r -	A 10	Aut.r	

Now, proceed as follows:

- 1) Push the P button for more than 3 seconds.

- 2) The upper display will show "PASS" while the lower display will show "0".
- 3) By ▲ and ▼ button set a password equal to - 81.
- 4) Push P button.  
The instrument will show the acronym of the first configuration parameter group "linP".
- 5) By U button select the group of the first parameter of your list.
- 6) By P button select the first parameter of your list
- 7) The upper display will show the acronym of the parameter while the lower display will show his current promotion level.

The promotion level is defined by a letter followed by a number.

The letter can be:

- "c": it shows that this parameter is NOT promoted and it is present only in configuration. In this case the number is forced to zero.
- "A": it shows that this parameter has been promoted to the limited access level. The number will show the position in the limited access list.
- "o": it shows that the parameter has been promoted to the Operator level. The number will show the position in the limited access list.

- 8) By ▲ and ▼ button assign to this parameter the desired position.

Note: setting a value different from 0 the letter "c" will change automatically to "A" and the parameter is automatically promoted to the limited access level.

- 9) In order to modify the level from limited access to operator and vice versa, push U button and, maintaining the pressure, push ▲ button.  
The letter will change from "A" to "o" and vice versa.
- 10) Select the second parameter that you want to add to the assistance level and repeat step 6, 7 and 8.
- 11) Repeat step 5, 6, 7, 8 until the list has been completed.
- 12) When you need to exit from promotion procedure, push U button and maintain the pressure for more than 10 seconds.

The instrument will show the "standard display".

**NOTE:** when you set the some number to two parameter, the instrument will use only the last programmed parameter.

**Example:** in the previous example, I have set for SP2 a promoton value equal to A3.

If now I set for SP3 a promotion value equal to o3, the Limited Access list and the operator list becomes.

Param.	Promotion	Limited Access	Operator
- OPEr -	o 1	OPEr	OPEr
- SP1 -	o 2	SP1	SP1
- SP3 -	o 3	SP3	SP3
- SPAt -	A 4	SPAt	
- AL1 -	o 5	AL1	AL1

.....

## 6. OPERATIVE MODES

As we said at paragraph 4.1, when the instrument is powered, it starts immediately to work according to the memorized parameter value.

In other words, the instrument has one status only, the "run time" status.

During "run time" we can force the instrument to operate in three different modes: Automatic mode, Manual mode or Stand by mode.

- In Automatic mode the instrument drives automatically the control output according to the parameter value set and the setpoint/measured value.

- In Manual mode the the upper display shows the measured value while the lower display shows the power output alternately to the "oPLo" messages and the instrument allows you to set manually the control output power.

No Automatic action will be made.

- In stand by mode the instrument operates as an indicator. It will show on the upper display the measured value and on the lower display the set point alternately to the "St,bY" messages and forces the control outputs to zero.

As we have seen, it is always possible to modify the value assigned to a parameter independently from the operative modes selected.

### 6.1 HOW TO ENTER IN THE "OPERATOR LEVEL"

The instrument is showing the "standard display".

- 1) Press the P button
- 2) The upper display will show the acronym of the first parameter promoted to this level while the lower display will show its value.
- 3) By ▲ and ▼ button assign to this parameter the desired value.
- 4) Press the P button in order to memorize the new value and go to the next parameter.
- 5) When you want to come back to the "standard display" push the U button for more than 5 seconds.

**NOTE:** the parameter modification of the Operator level is subject to a time out. If no button is pressed for more than 10 seconds, the instrument goes back to the "standard display" and the new value of the last selected parameter will be lost.

### 6.2 HOW TO ENTER IN "LIMITED ACCESS LEVEL"

The instrument is showing the "standard display".

- 1) Press the P button for more than 5 seconds
- 2) The upper display will show "PASS" while the lower display will show "0".
- 3) By ▲ and ▼ button set the value assigned to [114] PAS2 (Level 2 password).

#### NOTES:

- a) The factory default password for configuration parameters is equal to 20.
- b) All parameter modification are protected by a time

out. If no button is pressed for more than 10 second the instrument comes automatically back to the Standard display, the new value of the last selected parameter is lost and the parameter modification procedure is closed.

When you desire to remove the time out (e.g. for the first configuration of an instrument) you can use a password equal to 1000 plus the programmed password (e.g.  $1000 + 20$  [default] = 1020).

It is always possible to manually End the parameter configuration procedure (see below).

- c) During parameter modification the instrument continues to perform the control.

In certain conditions (e.g. when a parameter change can produces a heavy bump to the process) it is advisable to temporarily stop the controller from controlling during the programming procedure (its control output will be Off). A password equal to 2000 + the programmed value (e.g.  $2000 + 20 = 2020$ ) will switch the control out off during configuration. The control will restart automatically when the parameter modification procedure will be manually ended.

- 4) Push P button.
- 5) The instrument will show on the upper display the acronym of the first parameter promoted to this level and on the lower display its value.
- 6) By ▲ and ▼ button assign to this parameter the desired value.
- 7) Press the P button in order to memorize the new value and go to the next parameter.
- 8) When you want to come back to the "standard display" push the U button for more than 5 seconds.

### 6.3 HOW TO SEE BUT NOT MODIFY THE LIMITED ACCESS PARAMETERS

Sometime it is necessary to give to the operator the possibility to see the value assigned to the parameter promoted in the Limited Access level but it is important that all changes are made by authorized personnel only. In this cases, proceed as follows:

- 1) Press the P button for more than 5 seconds
- 2) The upper display will show "PASS" and the lower display will show "0".
- 3) By ▲ and ▼ button set the value -181.
- 4) Push P button.
- 5) The upper display will show the acronym of the first parameter promoted to the level 2 and lower display will show its value.
- 6) Using P button it is possible to see the value assigned to all parameter present in level 2 but it will not be possible to modify it.
- 7) It is possible to come back to the "standard display" by pushing the U button for more than 3 seconds or by pushing no pushbutton for more than 10 seconds.

## 6.4 AUTOMATIC MODE

### 6.4.1 Keyboard function when the instrument is in Auto mode

- U** It will perform the action programmed by [116] uSrb (U button function during RUN TIME) parameter.
- P** It allows entry into parameter modification procedures.
- ▲** It allows you to start the “Direct set point modification” function (see below).
- ▼** it allows you to display the “additional informations” (see below).

### 6.4.2 Direct set point modification

This function allows to modify rapidly the set point value selected by [79] SPAt (selection of the active Set point) or to the set point of the segment group (of the programmer) currently in progress. The instrument is showing the “standard display”.

- 1) Push **▼** button.  
The upper display will show the acronym of the selected set point (e.g. SP2) and the lower display will show its value  
**NOTE:** when the programmer is running, the instrument will show the set point of the group currently in use (e.g. if the instrument is performing the soak 3 the instrument will show [104] Pr.S3).
- 2) By **▲** and **▼** buttons, assign to this parameter the desired value
- 3) Do not push any button for more than 5 second or push the P button.  
In both cases the instrument memorize the new value and come back to the “standard display”.

**NOTE:** If the selected set point has not been promoted to the Operator level, the instrument allows you to see the value but not to modify it.

### 6.4.3 Additional informations

This instrument is able to show you some additional informations that can help you to manage your system. The additional informations are related to how the instrument is programmed, hence in many cases, only part of this information is available.

- 1) When the instrument is showing the “standard display” push **▲** button.  
The lower display will show “H” or “c” followed by a number. This value is the current power output applied to the process. The “H” show you that the action is a Heating action while the “c” show you that the action is a Cooling action.
- 2) Push **▲** button again. When the programmer is running the lower display will show the segment currently performed and the Event status as shown below:

where the first character can be “r” for a

ramp or “S” for a soak, the next digit show the number of the segment (e.g. S3 means Soak number 3) and the two less significant digits (LSD) show you the status of the two event (the LSD is the Event 2).

- 3) Push **▲** button again. When the programmer is running the lower display will show the theoretical remaining time to the end of the program preceded by a P letter:

- 4) Push **▲** button again. When the wattmeter function is running the lower display will show “U” followed by the measured energy.  
Note: The energy calculation will be in accordance with the [123] Co.tY parameter setting.
- 5) Push **▲** button again. When the “Worked time count” is running the lower display will show “d” for days or “h” for hours followed by the measured time.
- 6) Push **▲** button again. The instrument will come back to the “standard display”.

**NOTE:** The additional information visualization is subject to a time out. If no button is pressed for more than 10 second the instrument comes automatically back to the Standard display.

### 6.4.4 The programmer function

In paragraph 4 (page 18) we have described all parameters related with the programmer and their action during program execution.

In this paragraph we will give you some additional informations and some application examples.

#### Notes:

- The decimal point of the LSD of the lower display is used to show the programmer status independently from the displayed value selected by [114] diSP (Display management) .

Decimal point of the LSD.

The relation between the programmer status and the LED are the following:

- Program in RUN - the LED is ON.
- Program in Hold - The LED is flashing fast
- Program in wait - The LED is flashing slow
- Program in end or reset - The LED is OFF

#### Application Example 1: Spray Paint Drying Booth.

When the operator is in the booth and painting the car, the internal temperature must be 20 °C and the air, used for booth ventilation, comes from outside.

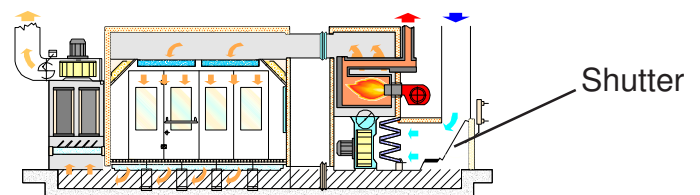

During the passivation and drying phases, the operator is out of the booth and the system closes the shutter of the air and recycles the internal air in order to reduce the power consumption.

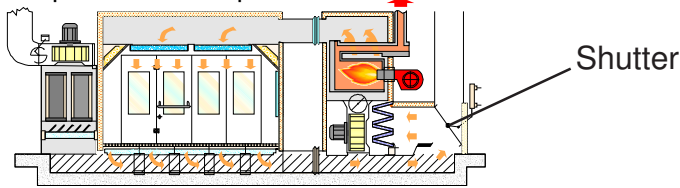

When the drying time is finished, before the operator is allowed to enter into the booth, you must be sure that:

- 1) the air in the booth has been refreshed
- 2) the temperature is lower than a limit.

So that you need a profile like below:

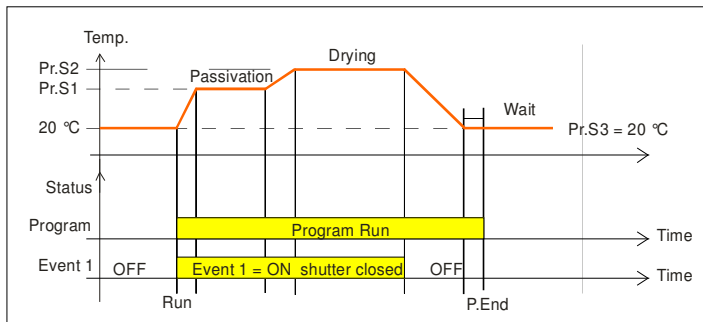

- Out 1 = H.rEG (heating output)
- Out 2 = P.Et1 (program event 1)
- Out 3 = P.run (program running)
- Pr.E1 and Pr.E2 = 10.10 (event 1 goes ON during ramp 1, soak 1, ramp 2 and soak 2)

When the program is running the door is locked

**Application Example 2:** edgb anding machine with glue tank (for wood).

At the working temperature the hot melt rapidly oxidizes and runs down from the “dispenser”. For this reason, when the machine does not work for a certain time, it is suitable to move the temperature of the dispenser to a lower value to idle.

In this cases the configuration is the following:

- Out 1 = h.reg (heating output)
- Out 2 = AL (alarm used to enable the dragger)
- diF.1 = P.run (dig. input 1 used for Program run/restart)
- Pr.F = S.uP.S (start at power up)
- Pr.E = cnt (Instrument behaviour at the end of the program execution = continue).

Connect a proximity switch to Dig. In 1 for panel detection.

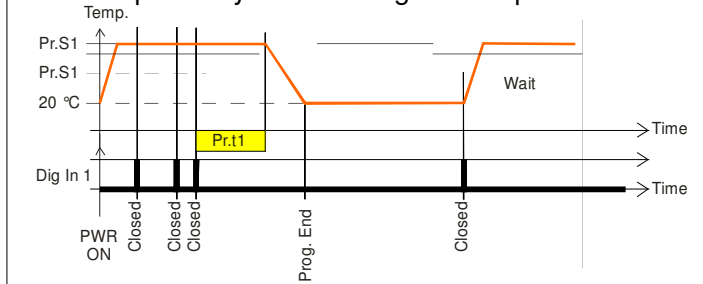

When a new panel is detected before the end of the first

soak time, the program restarts and the set point remain equal to Pr.S1.

If no panel is detected, the instrument goes to Pr.S2 (idle temp) and remain there until a new panel arrives.

**6.5 MANUAL MODES**

This operative mode allows you to deactivate automatic control and manually program the percentage power output to the process.

When the instruemnt is in manual mode, the upper display will show the measured value while the lower display will show alternately the power output [preceded by “H” (for heating action) or “C” (for cooling action)] and the message “oPLo” (open loop).

When manual control is selected, the instrument will start to operate with the same power output as the last one supplied by automatic mode and can be modified using the ▲ and ▼ buttons.

In case of ON/OFF control, 0% corresponds to the deactivated output while any value different from 0 corresponds to the activated output.

As in the case of visualization, the programmable values range from H100 (100% output power with reverse action) to C100 (100% output power with direct action).

**Note:**

- During manual mode, the absolute alarms are operative while the relative alarms are disabled.
- If you set manual modes during program execution, the program will be aborted.
- If you set manual modes during self-tune execution, the self- tune function will be aborted.
- During manual mode, all functions not related with the control (wattmeter, indipendent timer, “worked time”, etc) continue to operate normally.

**6.6 STAND BY MODE**

This operative mode also deactivates the automatic control but forces the control output to zero.

In this mode the instrument operates as an indicator. When the instrument is in stand by mode the upper display will show the measured value while the lower display will show alternately the set point and the message “St.bY”.

**Note:**

- During stand by mode, the relative alarms are disabled while the absolute alarms are operative or not according to the ALx0 (Alarm x enabling during Stand-by mode) parameter setting.
- If you set stand by mode during program execution, the program will be aborted.
- If you set stand by mode during self-tune execution, the self- tune function will be aborted.
- During stand by mode, all functions not related with the control (wattmeter, indipendent timer, “worked time”, etc) continue to operate normally.
- When the instrument is swapped from stand by to auto modes, the instrument will start automatically the alarm

masking, and the soft start functions.

## 7. ERROR MESSAGES

### 7.1 Out of range signals

The upper display shows the OVER-RANGE and UNDER-RANGE conditions with the following indications:

Over-range



Under-range



The sensor break will be signalled as an out of range



**NOTE:** When an over-range or an under-range is detected, the alarms operate as in presence of the maximum or the minimum measurable value respectively.

To check the out of span Error condition, proceed as follows:

- 1) Check the input signal source and the connecting line.
- 2) Make sure that the input signal is in accordance with the instrument configuration. Otherwise, modify the input configuration (see section 4).
- 3) If no error is detected, send the instrument to your supplier to be checked.

### 7.2 LIST OF POSSIBLE ERRORS

ErAT - Fast Auto-tune can't start. The measure value is too close to the set point.  
Push the P button in order to delete the error message.

NoAt - Auto-tune not finished within 12 hours.

ErEP- Possible problem of the instrument memory.  
The messages disappears automatically.  
When the error continues, send the instrument to your supplier.

## 8. - GENERAL NOTES

### 8.1 - PROPER USE

Every possible use not described in this manual must be consider as a improper use.

This instrument is in compliance with EN 61010-1 "Safety requirements for electrical equipment for measurement, control and laboratory use"; for this reason it could not be used as a safety equipment. Whenever a failure or a malfunction of the control device may cause dangerous situations for persons, thing or animals, please remember that the plant has to be equipped with additional safety devices.

**Tecnologic S.p.A. and its legal representatives do not assume any responsibility for any damage to people, things or animals deriving from violation, wrong or improper use or in any case not in compliance with**

**the instrument's features.**

### 8.2 - GUARANTEE AND REPAIRS

This product is under warranty against manufacturing defects or faulty materials that are found within 12 months from delivery date.

The guarantee is limited to repairs or to the replacement of the instrument.

The tampering of the instrument or an improper use of the product will bring about the immediate withdrawal of the warranty's effects.

In the event of a faulty instrument, either within the period of warranty, or further to its expiry, please contact our sales department to obtain authorisation for sending the instrument to our company.

The faulty product must be shipped to Tecnologic with a detailed description of the faults found, without any fees or charge for Tecnologic, except in the event of alternative agreements.

### 8.3 MAINTENANCE

This instrument does not requires periodical recalibration and it have no consumable parts so that no particular maintenance is required.

Some times, a cleaning action is suggestable.

- 1) SWITCH THE EQUIPMENT OFF (power supply, relay out, etc.).
- 2) Take the instrument out of its case.
- 3) Using a vacuum cleaner or a compressed air jet (max. 3 kg/cm<sup>2</sup>) remove all deposits of dust and dirt which may be present on the louvers and on the internal circuits being careful not to damage the electronic components.
- 4) To clean external plastic or rubber parts use only a cloth moistened with:
  - Ethyl Alcohol (pure or denatured) [C<sub>2</sub>H<sub>5</sub>OH] or
  - Isopropyl Alcohol (pure or denatured) [(CH<sub>3</sub>)<sub>2</sub>CHOH] or
  - Water (H<sub>2</sub>O).
- 5) Make sure that there are no loose terminals.
- 6) Before putting the instrument back in its case, make sure that it is perfectly dry.
- 7) Put the instrument back and turn it ON.

### 8.4 ACCESSORIES

The instrument has a lateral socket into which a special tool can be inserted. This tool, named A03, allows:

- To memorize a complete instrument configuration and to use it for other instruments.
- To transfer a complete instrument configuration to a PC or from a PC to an instrument
- To transfer from a PC to an instrument a complete instrument configuration
- To transfer a configuration from an A03 to another one.
- To test serial interface of the instruments and to help the OEM during machine start up.

# **TECNOLOGIC S.p.A.**

**VIA INDIPENDENZA 56**

**27029 VIGEVANO (PV) ITALY**

**TEL.: +39 0381 69871**

**FAX: +39 0381 698730**

**internet : <http://www.tecnologic.it>**

**e-mail: [info@tecnologic.it](mailto:info@tecnologic.it)**

## Appendix A

### InP group

n°	Parameter	Description	Dec.	Range	Def.	Vis. Promo.
1	HcFG	Parameter available by serial link. It shows the current hardware	0	TC/RTD TC/PTC Current Voltage	According to the Hardw.	Not vis
2	SEnS	Sensor selection (according to the hardware) TC, Pt100 input  TC, PTC, NTC input  I input  V input	0	J, crAL, S, r, t, ir.J, ir.cA, Pt1, 0.50 (mV), 0.60 (mV) 12.60 (mV)  J, crAL, S, r, t, Ir.J, Ir.cA, Ptc, ntc, 0.50 (mV), 0.60 (mV), 12.60 (mV)  0.20 (mA), 4.20 (mA)  0.5(V), 1.5(V), 0.10(V), 2.10(V), 0.1 (V)	J  Ptc  4.20  0.10	A-4
3	dP	Decimal figures	0	From 0 to 3	0	A-5
4	SSc	Initial scale readout	dP	From -1999 to FSC (E.U.)	-1999	A-6
5	FSc	Final scale readout	dP	From SSc to 9999 (E.U.)	9999	A-7
6	unit	Engineering unit	0	°c or °F	0 = °c	A-8
7	FiL	Digital filter on the measured value	1	From 0( oFF) to 20.0 (s)	1.0	C-0
8	inE	Selection of the Sensor Out of Range type that will enable the safety output value	0	or = Over-range ur = Under-range our = Over and Under	our	C-0
9	oPE	Safety output value	0	from -100 to 100 (%)	0	C-0
10	diF1	Digital input 1 function	0	oFF = No function 1 = Alarm Reset 2 = Alarm acknowledge (ACK) 3 = Hold of the measured value 4 = Stand by mode 5 = HEAt with SP1 and Cool with "SP2" 6 = Timer run/hold/reset [transition] 7 = Timer run [transition] 8 = Timer reset [transition] 9 = Timer run/hold [Status] 10 = Program run 11 = Program reset 12 = Program hold 13 = Program run/hold 14 = Program run/reset 15 = Instrument in Manual mode 16 = Sequential set point selection 17 = SP1 / SP2 selection 18 = Set point Binary selection 19 = Digital inputs in parallel to the UP and Down keys	nonE	A-13
11	diF2	Digital input 2 function	0	oFF = No function 1 = Alarm Reset 2 = Alarm acknowledge (ACK) 3 = Hold of the measured value 4 = Stand by mode 5 = HEAt with SP1 and Cool with "SP2" 6 = Timer run/hold/reset [transition] 7 = Timer run [transition] 8 = Timer reset [transition] 9 = Timer run/hold [Status] 10 = Program run 11 = Program reset 12 = Program hold 13 = Program run/hold	nonE	A-14

n°	Parameter	Description	Dec.	Range	Def.	Vis. Promo.
				14 = Program run/reset 15 = Instrument in Manual mode 16 = Sequential set point selection 17 = SP1 / SP2 selection 18 = Set point Binary selection 19 = Digital inputs in parallel to the UP and Down keys		

#### Out group

n°	Parameter	Description	Dec.	Range	Def.	Vis. Promo.
12	o1F	Out 1 function	0	NonE = Output not used, H.rEG = Heating output c.rEG = Cooling output AL = Alarm output t.out = Timer output t.HoF = Timer out -OFF in hold P.End = Program end indicator P.HLd = Program hold indicator P. uit = Program wait indicator P.run = Program run indicator P.Et1 = Program Event 1 P.Et2 = Program Event 2 or.bo = Out-of-range or burn out indicator P.FAL = Power failure indicator bo.PF = Out-of-range, burn out and Power failure indicator diF.1 = The output repeats the digital input 1 status diF.2 = The output repeats the digital input 2 status St.bY = Stand by status indicator	H.reg	A-16
13	o1AL	Alarms linked up with the out 1	0	from 0 to 15 +1 = Alarm 1 +2 = Alarm 2 +4 = Alarm 3 +8 = Loop break alarm	AL1	A-17
14	o1Ac	Out 1 action	0	dir = Direct action rEU = Reverse action dir.r = Direct with reversed LED ReU.r = Reverse with reversed LED	dir	C-0
15	o2F	Out 2 function	0	NonE = Output not used H.rEG = Heating output c.rEG = Cooling output AL = Alarm output t.out = Timer output t.HoF = Timer out -OFF in hold P.End = Program end indicator P.HLd = Program hold indicator P. uit = Program wait indicator P.run = Program run indicator P.Et1 = Program Event 1 P.Et2 = Program Event 2 or.bo = Out-of-range or burn out indicator P.FAL = Power failure indicator bo.PF = Out-of-range, burn out and Power failure indicator diF.1 = The output repeats the digital input 1 status diF.2 = The output repeats the digital input 2 status St.bY = Stand by status indicator	AL	A-19
16	o2AL	Alarms linked up with the out 2	0	From 0 to 15 +1 = Alarm 1 +2 = Alarm 2 +4 = Alarm 3 +8 = Loop break alarm	AL1	A-20



n°	Parameter	Description	Dec.	Range	Def.	Vis. Promo.
17	o2Ac	Out 2 action	0	dir = Direct action rEU = Reverse action dir.r = Direct with reversed LED ReU.r = Reverse with reversed LED	dir	C-0
18	o3F	Out 3 function	0	NonE = Output not used H.rEG = Heating output c.rEG = Cooling output AL = Alarm output t.out = Timer output t.HoF = Timer out -OFF in hold P.End = Program end indicator P.HLd = Program hold indicator P. uit = Program wait indicator P.run = Program run indicator P.Et1 = Program Event 1 P.Et2 = Program Event 2 or.bo = Out-of-range or burn out indicator P.FAL = Power failure indicator bo.PF = Out-of-range, burn out and Power failure indicator diF.1 = The output repeats the digital input 1 status diF.2 = The output repeats the digital input 2 status St.bY = Stand by status indicator	AL	A-22
19	o3AL	Alarms linked up with the out 3	0	From 0 to 15 +1 = Alarm 1 +2 = Alarm 2 +4 = Alarm 3 +8 = Loop break alarm	AL2	A-23
20	o3Ac	Out 3 action	0	dir = Direct action rEU = Reverse action dir.r = Direct with reversed LED ReU.r = Reverse with reversed LED	dir	C-0
21	o4F	Out 4 function	0	NonE = Output not used H.rEG = Heating output c.rEG = Cooling output AL = Alarm output t.out = Timer output t.HoF = Timer out -OFF in hold P.End = Program end indicator P.HLd = Program hold indicator P. uit = Program wait indicator P.run = Program run indicator P.Et1 = Program Event 1 P.Et2 = Program Event 2 or.bo = Out-of-range or burn out indicator P.FAL = Power failure indicator bo.PF = Out-of-range, burn out and Power failure indicator diF.1 = The output repeats the digital input 1 status diF.2 = The output repeats the digital input 2 status St.bY = Stand by status indicator	AL	A-24
22	o4AL	Alarms linked up with the out 3	0	From 0 to 15 +1 = Alarm 1 +2 = Alarm 2 +4 = Alarm 3 +8 = Loop break alarm	AL2	A-25
23	o4Ac	Out 3 action	0	dir = Direct action rEU = Reverse action dir.r = Direct with reversed LED ReU.r = Reverse with reversed LED	dir	C-0

**AL1 group**

n°	Parameter	Description	Dec.	Range	Def.	Vis Promo.
24	AL1t	Alarm 1 type	0	nonE = Alarm not used LoAb = Absolute low alarm HiAb = Absolute high alarm LHAb = Absolute band alarm LodE = Deviation low alarm (relative) HidE = Deviation high alarm (relative) LHdE = Relative band alarm	LoAb	A-47
25	Ab1	Alarm 1 function	0	From 0 to 15 +1 = Not active at power up +2 = Latched alarm (manual reset) +4 = Acknowledgeable alarm +8 = Relative alarm not active at set point change	0	C-0
26	AL1L	- For High and low alarms, it is the low limit of the AL1 threshold - For band alarm, it is low alarm threshold	dP	From -1999 to AL1H ( E.U.)	-1999	A-48
27	AL1H	- For High and low alarms, it is the high limit of the AL1 threshold - For band alarm, it is high alarm threshold	dP	From AL1L to 9999 ( E.U.)	9999	A-49
28	AL1	AL1 threshold	dP	From AL1L to AL1H (E.U.)	0	A-50
29	HAL1	AL1 hysteresis	dP	From 1 to.9999 (E.U.)	1	A-51
30	AL1d	AL1 delay	dP	From 0 (oFF) to 9999 (s)	oFF	C-0
31	AL1o	Alarm 1 enabling during Stand-by mode	0	no = alarm 1 disabled during Stand-by YES = alarm 1 enabled during Stand-by	no	C-0

**AL2 group**

n°	Parameter	Description	Dec.	Range	Def.	Vis Promo.
32	AL2t	Alarm 2 type	0	nonE = Alarm not used LoAb = Absolute low alarm HiAb = Absolute high alarm LHAb = Absolute band alarm LodE = Deviation low alarm (relative) HidE = Deviation high alarm (relative) LHdE = Relative band alarm	HiAb	A-54
33	Ab2	Alarm 2 function	0	From 0 to 15 +1 = Not active at power up +2 = Latched alarm (manual reset) +4 = Acknowledgeable alarm +8 = Relative alarm not active at set point change	0	C-0
34	AL2L	- For High and low alarms, it is the low limit of the AL2 threshold - For band alarm, it is low alarm threshold	dP	From -1999 to AL2H (E.U.)	-1999	A-56
35	AL2H	- For High and low alarms, it is the high limit of the AL2 threshold - For band alarm, it is high alarm threshold	dP	From AL2L to 9999 (E.U.)	9999	A-57
36	AL2	Alarm 2 threshold	dP	From AL2L to AL2H (E.U.)	0	A-58
37	HAL2	Alarm 2 hysteresis	dP	From 1 to 9999 (E.U.)	1	A-59
38	AL2d	Alarm 2 delay	dP	From 0 (oFF) to 9999 (s)	oFF	C-0
39	AL2o	Alarm 2 enabling during Stand-by mode	0	no = alarm 2 disabled during Stand-by YES = alarm 2 enabled during Stand-by	no	C-0

**AL3 group**

n°	Parameter	Description	Dec.	Range	Def.	Vis Promo.
40	AL3t	Alarm 3 type	0	nonE = Alarm not used LoAb = Absolute low alarm HiAb = Absolute high alarm LHAb = Absolute band alarm LodE = Deviation low alarm (relative) HidE = Deviation high alarm (relative) LHdE = Relative band alarm	nonE	C-0
41	Ab3	Alarm 3 function	0	From 0 to 15 +1 = Not active at power up +2 = Latched alarm (manual reset) +4 = Acknowledgeable alarm +8 = Relative alarm not active at set point change	0	C-0
42	AL3L	- For High and low alarms, it is the low limit of the AL3 threshold - For band alarm, it is low alarm threshold	dP	From -1999 to AL3H ( E.U.)	-1999	C-0
43	AL3H	- For High and low alarms, it is the high limit of the AL3 threshold - For band alarm, it is high alarm threshold	dP	From AL3L to 9999 ( E.U.)	9999	C-0
44	AL3	Alarm 3 threshold	dP	From AL3L to AL3H ( E.U.)	0	C-0
45	HAL3	Alarm 3 hysteresis	dP	From 1 to.9999 ( E.U.)	1	C-0
46	AL3d	Alarm 3 delay	dP	From 0 (oFF) to 9999 (s)	oFF	C-0
47	AL3o	Alarm 3 enabling during Stand-by mode	0	no = alarm 2 disabled during Stand-by YES = alarm 2 enabled during Stand-by	no	C-0

**LbA group**

n°	Parameter	Description	Dec.	Range	Def.	Vis Promo.
48	LbAt	LBA time	0	From 0 (oFF) to 9999 (s)	oFF	C-0
49	LbSt	Delta measure used by LBA during Soft start.	dP	From 0 (oFF) to 9999 ( E.U.)	10	C-0
50	LbAS	Delta measure used by LBA	dP	From 1 to 9999 ( E.U.)	20	C-0
51	LbcA	Condition for LBA enabling	0	uP = Active when Pout = 100% dn = Active when Pout = -100% both = Active in both cases	both	C-0

**rEG group**

n°	Parameter	Description	Dec.	Range	Def.	Vis Promo.
52	cont	Control type	0	Pid = PID (heat and/or cool) On.FA = ON/OFF asymmetric hysteresis On.FS = ON/OFF symmetric hysteresis nr = Heat/Cool ON/OFF control with neutral zone	Pid	A-25

n°	Parameter	Description	Dec.	Range	Def.	Vis Promo.
53	Auto	Autotuning selection	0	-4 = Oscillating auto-tune with automatic restart at power up and after <b>all</b> set point change -3 = Oscillating auto-tune with manual start -2 = Oscillating auto-tune with auto-matic start at the first power up only -1 = Oscillating auto-tune with auto-matic restart at every power up 0 = Not used 1 = Fast auto tuning with automatic restart at every power up 2 = Fast auto-tune with automatic start at the first power up only 3 = FAST auto-tune with manual start 4 = FAST auto-tune with automatic restart at power up and after a set point change	2	C-0
54	Aut.r	Manual start of the Autotuning	0	oFF = Not active on = Active	oFF	A-26
55	SELF	Self tuning enabling	0	oFF = The instrument do not perform the self-tuning on = The instrument is performing the self-tuning	no	C-0
56	HSEt	Hysteresis of the ON/OFF control	dP	From 0 to 9999 ( E.U.)	1	A-27
57	cPdt	Time for compressor protection	0	From 0 (oFF) to 9999 (s)	oFF	C-0
58	Pb	Proportional band	dP	From 0 to 9999 ( E.U.)	50	A-28
59	int	Integral time	0	From 0 (oFF) to 9999 (s)	200	A-29
60	dEr	Derivative time	0	From 0 (oFF) to 9999 (s)	50	A-30
61	Fuoc	Fuzzy overshoot control	2	From 0.00 to 2.00	0.50	A-31
62	H.Act	Heating output actuator	0	SSr = SSR rELY = relay SLou = slow actuators	SSr	A-32
63	tcrH	Heating output cycle time	1	From 0.1 to 130.0 (s)	20.0	C-0
64	PrAt	Power ratio between heating and cooling action	2	From 0.01 to 99.99	1.00	A-34
65	c.Act	Cooling output actuator	0	SSr = SSR rELY = relay SLou = slow actuators	SSr	A-35
66	tcrc	Cooling output cycle time	1	From 0.1 to 130.0 (s)	20.0	C-0
67	rS	Manual reset (Integral pre-load)	1	From -100.0 to 100.0 (%)	0.0	C-0
68	od	Delay at power up	2	From 0.00 (oFF) to 99.59 (hh.mm)	oFF	C-0
69	St.P	Maximum power output used during soft start	0	From -100 to 100 (%)	0	C-0
70	SSt	Soft start time	2	From 0.00 (oFF) to 8.00 (inF) (hh.mm)	oFF	C-0
71	SStH	Threshold for soft start disabling	dP	From -1999 to 9999 (E.U.)	9999	C-0

#### SP Group

n°	Parameter	Description	Dec.	Range	Def.	Vis. Promo.
72	nSP	Number of used set points	0	From 1 to 4	1	A-38
73	SPLL	Minimum set point value	dP	From -1999 to SPHL	-1999	A-39
74	SPHL	Maximum set point value	dP	From SPLL to 9999	9999	A-40
75	SP 1	Set point 1	dP	From SPLL to SPLH	0	O-41
76	SP 2	Set point 2	dP	From SPLL to SPLH	0	O-42
77	SP 3	Set point 3	dP	From SPLL to SPLH	0	O-43
78	SP 4	Set point 4	dP	From SPLL to SPLH	0	O-44
79	SPAt	Selection of the active set point.	0	From 1 ( SP 1) to nSP	1	O-45

n°	Parameter	Description	Dec.	Range	Def.	Vis. Promo.
80	SP.rt	Remote set point type	0	RSP = The value coming from serial link is used as remote set point trin = The value will be added to the local set point selected by SPAt and the sum becomes the operative set point PErc = The value will be scaled on the input range and this value will be used as remote set point	trin	C-0
81	SP.Lr	Local/remote set point selection	0	Loc = local rEn = remote	Loc	C-0
82	SP.u	Rate of rise for POSITIVE set point change	2	From 0.01 to 100.00 ( inF) Engineering units per minute	inF	C-0
83	SP.d	Rate of rise for NEGATIVE set point change	2	0.01 ÷ 100.00 ( inF) Engineering units per minute	inF	C-0

#### Tin Group

n°	Parameter	Description	Dec.	Range	Def.	Vis. Promo.
84	tr.F	Independent timer function	0	NonE = Timer not used i.d.A = Delayed start timer i.uP.d = Delayed start at power up i.d.d = Feed-through timer i.P.L = Asymmetrical oscillator with start in OFF i.L.P = Asymmetrical oscillator with start in ON	nonE	A-62
85	tr.u	Timer unit	0	hh.nn = Hours and minutes nn.SS = Minutes and seconds SSS.d = Second and tenth of seconds	nn.SS	A-63
86	tr.t1	Time 1	2 1	From 00.01 to 99.59 when tr.u < 2 From 000.1 to 995.9 when tr.u = 2	1.00	A-64
87	tr.t2	Time 2	2 1	When tr.u < 2: From 00.00 (oFF) to 99.59 (inF) When tr.u = 2: From 000.0 (oFF) to 995.9 (inF)	1.00	A-65
88	tr.St	Timer status	0	rES = timer reset run = timer run HoLd = timer hold	rES	C-0

#### PrG Group

n°	Parameter	Description	Dec.	Range	Def.	Vis. Promo.
89	Pr.F	Program action at power up	0	nonE = Programmer not used S.uP.d = Start at power up with a first step in stand-by S.uP.S = Start at power up u.diG = Start at Run command detection only u.dG.d = Start at Run command with a first step in stand-by	nonE	A-67
90	Pr.u	Engineering unit of the soak	2	hh.nn = Hours and minutes nn.SS = Minutes and seconds	hh.nn	A-68
91	Pr.E	Instrument behaviour at the end of the program execution.	0	cnt = continue SPAt = go to the set point selected by SPAt St.by = go to stand-by mode	SPAt	A-71
92	Pr.Et	Time of the end program indication	2	From 0.00 (oFF) to 100.00 (inF) minutes and seconds	oFF	A-72
93	Pr.S1	Set point of the first soak	dP	From SPll to SPHl	0	A-73
94	Pr.G1	Gradient of the first ramp	1	From 0.1 to 1000.0 (inF= Step transfer) Engineering Unit/minute	inF	A-74
95	Pr.t1	Time of the first soak	2	From 0.00 to 99.59	0.10	A-75
96	Pr.b1	Wait band of the first soak	dP	From 0 (oFF) to 9999 (E.U.)	oFF	A-76

n°	Parameter	Description	Dec.	Range	Def.	Vis. Promo.
97	Pr.E1	Events of the first group	2	From 00.00 to 11.11	00.00	C-0
98	Pr.S2	Set point of the second soak	dP	OFF or from SPLL to SPHL	0	A-78
99	Pr.G2	Gradient of the second ramp	1	From 0.1 to 1000.0 (inF= Step transfer) Engineering Unit/minute	inF	A-79
100	Pr.t2	Time of the second soak	2	From 0.00 to 99.59	0.10	A-80
101	Pr.b2	Wait band of the second soak	dP	From 0 (oFF) to 9999 (E.U.)	oFF	A-81
102	Pr.E2	Events of the second group	2.	From 00.00 to 11.11	00.00	C-0
103	Pr.S3	Set point of the third soak	dP	OFF or from SPLL to SPHL	0	A-83
104	Pr.G3	Gradient of the third ramp	1	From 0.1 to 1000.0 (inF= Step transfer) Engineering Unit/minute	inF	A-84
105	Pr.t3	Time of the third soak	2	From 0.00 to 99.59	0.10	A-85
106	Pr.b3	Wait band of the third soak	dP	From 0 (oFF) to 9999 (E.U.)	oFF	A-86
107	Pr.E3	Events of the third group	0	From 00.00 to 11.11	00.00	C-0
108	Pr.S4	Set point of the fourth soak	dP	OFF or from SPLL to SPHL	0	A-88
109	Pr.G4	Gradient of the fourth ramp	1	From 0.1 to 1000.0 (inF= Step transfer) Engineering Unit/minute	inF	A-89
110	Pr.t4	Time of the fourth soak	2	From 0.00 to 99.59	0.10	A-90
111	Pr.b4	Wait band of the fourth soak	dP	From 0 (oFF) to 9999 (E.U.)	oFF	A-91
112	Pr.E4	Events of the fourth group	0	From 00.00 to 11.11	00.00	C-0
113	Pr.St	Program status	0	rES = Program reset run = Program start HoLd = Program hold	0	C-0

#### Pan Group

n°	Parameter	Description	Dec.	Range	Def.	Vis. Promo.
114	PAS2	Password level 2	0	From 0 (oFF) to 999	20	A-93
115	PAS3	Password level 3	0	From 1 to 999	30	C-0
116	uSrb	U button function during run time	0	nonE = Not used tunE = Starts auto tuning functions oPLo = Manual mode (OPLO) AAc = Alarm reset ASi = Alarm acknowledge chSP = Sequential set point selection St.by = Stand-by mode Str.t = Run/hold/reset timer P.run = Program start P.rES = program reset P.r.H.r = Run/hold/reset program	nonE	A-94

n°	Parameter	Description	Dec.	Range	Def.	Vis. Promo.
117	diSP	Display management	0	nonE = Standard display Pou = Power output SPF = Final set point Spo = Operative set point AL1 = Alarm 1 threshold AL2 = Alarm 2 threshold AL3 = Alarm 3 threshold Pr.tu = Program time up Pr.td = Program time down P.t.tu = Program total time up P.t.td = Program total time down ti.uP = Timer time up ti.du = Timer time down PErc = Percent of the power output used during soft start (when the soft start time is equal to infinite, the limit is ever active and it can be used also when ON/OFF control is selected)	nonE	A-95
118	AdE	Bargraph deviation	dP	From 0 (oFF) to 9999	2	A-96
119	FiLd	Filter on the displayed value	1	From 0 .0(oFF) to 20.0	oFF	C-0
120	dSPu	Status of the instrument at power up	0	AS.Pr = Starts in the same way it was prior to the power down Auto = Starts in Auto mode oP.0 = Starts in manual mode with a power output equal to zero St.bY = Starts in stand-by mode	AS.Pr	C-0
121	oPr.E	Operative mode enabling	0	ALL = All Au.oP = Autp or manual (oPLo) only Au.Sb = Auto and Stand by only	ALL	C-0
122	oPEr	Operative mode selection	0	Auto = Automatic oPLo = Manual St.by = Stand-by	Auto	O-1

#### Ser group

n°	Parameter	Description	Dec.	Range	Def.	Vis. Promo.
123	Add	Address	0	0 (oFF) ÷ 254	1	C-0
124	bAud	Baud rate	0	1200 2400 9600 19.2 38.4	9600	C-0
125	trSP	Selection of the value to be retransmitted (Master)	0	nonE = Not used rSP = Operative set point PErc = Current power output (%)	nonE	C-0

#### con group (Wattmeter)

n°	Parameter	Description	Dec.	Range	Def.	Vis. Promo.
126	co.ty	Measurement type	0	oFF = Not used 1 = Instantaneous power (kW) 2 = Power consumption (kW/h) 3 = Energy used during program execution 4 = Total worked days with threshold 5 = Total worked hours with threshold	nonE	A-97
127	UoLt	Nominal voltage of the load	0	From 1 to 999 (Volt)	230	A-98
128	cur	Nominal current of the load	0	From 1 to 999 (A)	10	A-99
129	h.Job	Threshold of the worked hours/days	0	From 0(oFF) to 9999	oFF	A-100

**CAL Group** (User calibration)

n°	Para metro	Ddescription	Dec.	Range	Def.	Vis. Promo.
130	A.L.P	Adjust low Point	dP	From -1999 to AH.P-10 (E.U.)	0	A-9
131	A.L.o	Adjust low Offset	dP	From -300 to 300 (E.U.)	0	A-10
132	A.H.P	Adjust High Point	dP	From A.L.P +10 ÷to 9999 (E.U.)	9999	A-11
133	A.H.o	Adjust High Offset	dP	From -300 to 300 (E.U.)	0	A-12