



# TLY 29

## MICROPROCESSOR-BASED DIGITAL ELECTRONIC FREEZER CONTROLLER



### OPERATING INSTRUCTIONS Vr. 01 (ENG) - cod.: ISTR 06408

**TECNOLOGIC S.p.A.**

VIA INDIPENDENZA 56  
27029 VIGEVANO (PV) ITALY

TEL.: +39 0381 69871

FAX: +39 0381 698730

internet : <http://www.tecnologic.it>

e-mail: [info@tecnologic.it](mailto:info@tecnologic.it)

#### FOREWORD

This manual contains the information necessary for the product to be installed correctly and also instructions for its maintenance and use; we therefore recommend that the utmost attention is paid to the following instructions.

Though this manual has been issued with the greatest care, TECNOLOGIC S.p.A. will not take any responsibility deriving from its use.

The same applies to each person or Company involved in the issuing of this manual.

This document is the exclusive property of TECNOLOGIC S.p.A. which forbids any reproduction and divulgation, even in part, of the document, unless expressly authorized.

TECNOLOGIC S.p.A. reserves the right to make any formal or functional changes at any moment and without any notice.

#### INDEX

- 1 INSTRUMENT DESCRIPTION**
  - 1.1 GENERAL DESCRIPTION
  - 1.2 FRONT PANEL DESCRIPTION
- 2 PROGRAMMING**
  - 2.1 PROGRAMMING OF SET POINT
  - 2.2 PARAMETERS PROGRAMMING
  - 2.3 PARAMETER PROTECTION USING THE PASSWORD
  - 2.4 PARAMETERS PROGRAMMING LEVEL
  - 2.5 ACTIVE SET POINT SELECTION
  - 2.6 ON / STAND-BY FUNCTION
  - 2.7 CLOCK PROGRAMMING
- 3 INFORMATION ON INSTALLATION AND USE**
  - 3.1 PERMITTED USE
  - 3.2 MECHANICAL MOUNTING
  - 3.3 ELECTRICAL CONNECTIONS
  - 3.4 ELECTRICAL WIRING DIAGRAM
- 4 FUNCTIONS**
  - 4.1 MEASURING AND VISUALIZATION
  - 4.2 OUTPUTS CONFIGURATION
  - 4.3 TEMPERATURE CONTROL
  - 4.4 CONTINUOUS CYCLE FUNCTION
  - 4.5 COMPRESSOR PROTECTION FUNCTION AND AND DELAY AT POWER-ON
  - 4.6 DEFROST CONTROL
  - 4.7 MANUAL DEFROST
  - 4.8 EVAPORATOR FANS CONTROL
  - 4.9 ALARM FUNCTIONS
    - 4.9.1 TEMPERATURE ALARMS
    - 4.9.2 EXTERNAL ALARM
    - 4.9.3 OPEN DOOR ALARM
    - 4.9.4 ALARM MEMORY
  - 4.10 DIGITAL INPUT
  - 4.11 AUXILIARY OUTPUT
  - 4.12 FUNCTION OF KEYS "U" AND "DOWN/AUX"
  - 4.13 PARAMETERS CONFIGURATION BY KEY01
- 5 PROGRAMMABLE PARAMETERS TABLE**
- 6 PROBLEMS, MAINTENANCE AND GUARANTEE**
  - 6.1 SIGNALLING
  - 6.2 CLEANING
  - 6.3 GUARANTEE AND REPAIRS
- 7 TECHNICAL DATA**
  - 7.1 ELECTRICAL DATA
  - 7.2 MECHANICAL DATA
  - 7.3 MECHANICAL DIMENSIONS, PANEL CUT-OUT AND MOUNTING
  - 7.4 FUNCTIONAL DATA
  - 7.5 INSTRUMENT ORDERING CODE

#### 1 - INSTRUMENT DESCRIPTION

##### 1.1 - GENERAL DESCRIPTION

The model TLY 29 is a digital controller with microprocessor that is typically used in cooling applications that have temperature control with ON/OFF regulation and defrosting control with set time and hours intervals (Real Time Clock Defrosting) by means of electrical heating or hot gas/cycle inversion.

The instrument has 3 relay outputs, two inputs for PTC or NTC temperature probes and a digital input, that can all be configured.

The 3 outputs can be used for controlling the compressor or the temperature control device (OUT), the defrosting device (DEF), the evaporation fan (FAN) or, alternatively any of the previous functions, using an auxiliary device (AUX) or an alarm (AL).

The two inputs for the PTC and NTC temperature probes (which can be selected by parameter) can be used to measure the cell temperature (Pr1) and the evaporator temperature (Pr2) while the digital input (DIG) can be programmed to carry out various functions such as defrosting commands, selecting a different set of temperature regulations, external alarm signals, activating a continuous cycle, and activating an auxiliary output etc.

The instrument is equipped with 4 programme keys, a 4-digit display and 9 LED signals, in addition to an internal buzzer that is the sound system for alarms.

Other important characteristics of the instrument are: programme parameters protection using personalised password, switching on and off (stand-by) of the instrument using the front keys or the digital input, configuration of parameters via the KEY 01 device, memorising of two sets of temperature regulations that can be switched and the possibility of power supply in the range 100 ... 240 VAC.

## 1.2 - FRONT PANEL DESCRIPTION

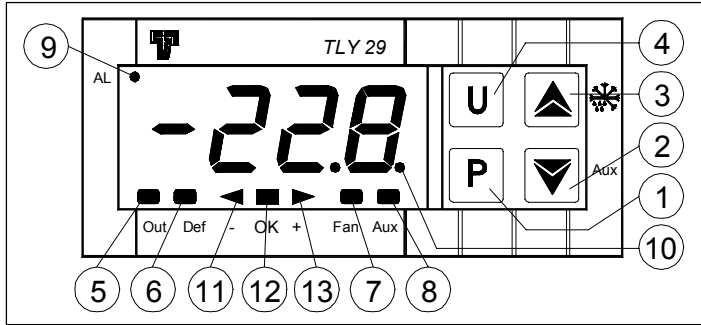

**1 - Key P** : Used for setting the Set point and for programming the function parameters

**2 - Key DOWN/Aux** : Used for decreasing the values to be set and for selecting the parameters. It can also be programmed via the parameter "Fbd" to carry out other functions such as activating the Aux output, starting up the continuous cycle, selecting the active set point or turning on and off (stand-by) the device (see par. 4.12).

**3 - Key UP/DEFROST** : Used for increasing the value to be set, for selecting the parameters and for activating manual defrosting.

**4 - Key U** : Used for visualising the temperatures taken by the cell probes and evaporator (Pr1 and Pr2) and the internal clock (if present). It can also be programmed via the parameter "USrb" to carry out other functions, just like the key DOWN/AUX (see par. 4.12).

**5 - Led OUT** : Indicates the compressor output status (or the temperature control device) on (on), off (off) or inhibited (flashing)

**6 - Led DEF** : Indicates defrosting in progress (on) or dripping (flashing).

**7 - Led FAN** : Indicates fan output status on (on), off (off) or delayed after defrosting (flashing)

**8 - Led AUX** : Indicates AUX output status on (on), off (off) or inhibited (flashing)

**9 - Led AL** : Indicates the alarm status (on), off (off) and silenced or memorized (flashing)

**10 - Led SET** : Indicates the input in programming mode and the programming level of the parameters. It also serves to indicate the Stand-by status.

**11 - Led -** : Indicates that a low temperature alarm is in progress (lit) or that a low temperature alarm has been memorised (flashing).

**12 - Led OK** : Indicates that no alarms are in progress

**13 - Led +** : Indicates that a high temperature alarm is in progress (lit) or that a high temperature alarm has been memorised (flashing).

## 2 - PROGRAMMING

### 2.1 - PROGRAMMING OF THE SET POINT

Press the key **P** then release it and the display will show **SP 1** (or **SP 2** if the second set is active at that time) alternating with the set value (see selection of the active set point).

To change it press the UP key to increase the value or DOWN to decrease it.

These keys increase or decrease the value one digit at a time, but if the button is pressed for more than one second the value increase or decreases rapidly, and after two seconds pressed, the speed increases even more to all the desired value to be reached rapidly.

Exiting the Set mode is achieved by pressing the P key or automatically if no key is pressed for 15 seconds. After that time the display returns to the normal function mode.

### 2.2 - PARAMETERS PROGRAMMING

To access the instrument's function parameters, press the key **P** and keep it pressed for about 5 seconds, after which the SET led will light up, the display will visualise the code that identifies the first group of parameters ("SP") and the group of parameters that are to be edited are selected by pressing the UP and DOWN keys. Once the group of parameters has been selected, press the P and the code that identifies the first parameter in the selected group will be visualised.

Again using the UP and DOWN keys, the desired parameter can be selected and pressing the P key, the display will alternately show the parameter code and its setting that can be changed with the UP and DOWN keys.

Once the desired value has been set, press the key P again: the new value will be memorised and the display will show only the abbreviation of the selected parameter.

Pressing the UP and DOWN keys, it is possible to select another parameter (if present) and change it as described.

To return to select another group of parameters, keep the UP or the DOWN key pressed for about 1 second, after which the display will return to showing the code of the parameter group.

Release the pressed key and using the UP and DOWN keys it will be possible to select another group (if present).

To exit the programming mode, do not press any key for about 20 seconds, or keep the UP or DOWN key pressed until it exits the programming mode.

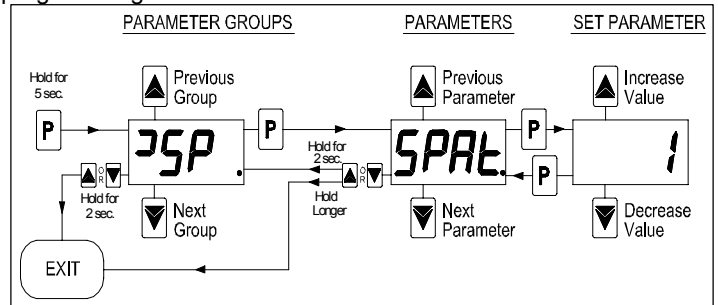

### 2.3 - PARAMETER PROTECTION USING THE PASSWORD

The instrument has a parameter protection function using a password that can be personalised, through the "PASS" parameter in the "iPan" set.

If one wishes to have this protection, set the password number desired in the parameter "PASS".

When the protection is working, press the P key to access the parameters and keep it pressed for about 5 seconds, after which the LED SET will flash and the display will show "0".

At this point, using the UP and DOWN keys, set the password number programmed and press the key "P".

If the password is correct, the display will visualise the code that identifies the first group of parameters ("SP") and it will be possible to programme the instrument in the same ways described in the previous section.

Protection using a password can be disabled by setting the parameter "PASS" = OFF.

### 2.4 - PARAMETERS PROGRAMMING LEVELS

The instrument has two parameter programming levels.

The first level ("visible" parameters) is accessed according to the procedure described above (with or without password request) while the second level ("hidden" password) can be accessed according to the following procedure.

Remove the power supply to the instrument, press the key P and return power to the instrument, keeping the key pressed.

After about 5 sec. the SET led will light up, the display will show the code that identifies the first group of parameters ("SP") and it will be possible to set the parameters of the instrument using the same programming procedure described previously.

Once the parameter has been selected and the SET is on, it means that the parameter can be programmed even on the first level ("visible").

If the LED is off it means that the parameter can only be programmed on this level (i.e. "hidden").

To change the visibility of the parameter, press the key U: the led SET will change status, indicating the accessibility level of the parameter (on = parameter "visible"; off = parameter "hidden").

The access procedure for "hidden" parameters allows the "PASS" parameter to be checked and changed, and is useful therefore if the password set has been forgotten.

### 2.5 - ACTIVE SET POINT SELECTION

The instrument allows up to 2 different regulation Set points to be pre-set ("SP 1" and "SP 2") and then to choose which one to make active.

This function can be used if it is necessary to switch two different function temperatures (e.g. day and night or positive and negative etc).

The active set point can be selected:

- Using the parameter "SPAt"
- using the key U if the parameter "USrb" = 3.
- Using the key DOWN/AUX if the parameter "Fbd" = 3.
- Using the digital input if the parameter. "diF" = 8

(see par. 4.10 e 4.12)

The Set points "SP1" and "SP2" can be set with a value between the programmed value in parameter. "SPLL" and the programmed value in parameter "SPHL".

*Nota: in the examples that follow, the Set point is generally indicated as "SP", how when operating the instrument will work according to the Set point selected as active.*

### 2.6 - ON / STAND-BY FUNCTION

The instrument, once powered up, can assume 2 different conditions:

- ON : means that the controller uses the control functions.
  - STAND-BY : means that the controller does not use any control function and the display is turned off except for the green SET led.
- If there is no power, and then power returns, the system always sets itself in the condition it was in before the black-out.

The ON/Stand-by function can be selected:

- Using the key U if the parameter "USrb" = 4.
  - Using the key DOWN/AUX if the parameter "Fbd" = 4.
  - using the digital input if the parameter "diF" = 10
- (see par. 4.10 e 4.12)

### 2.7 - TIME SETTING

When the instrument has an internal clock it is necessary to programme it on the current time by using the parameter "StCL" contained in the group "CLO".

The instrument has an internal quartz for the clock, however, should the clock become inaccurate (especially over a long period) it can be adjusted daily using the parameter "CLOF" contained in the same group.

The working of the clock is guaranteed by an internal condenser for a period of about 4 hours without any power to the instrument.

If the instrument should remain without power for a long period, remember to check and if necessary re-programme the exact time.

## 3 - INFORMATION ON INSTALLATION AND USE



### 3.1 - PERMITTED USE

The instrument has been projected and manufactured as a measuring and control device to be used according to EN61010-1 for the altitudes operation until 2000 ms.

The use of the instrument for applications not expressly permitted by the above mentioned rule must adopt all the necessary protective measures.

The instrument CANNOT be used in dangerous environments (flammable or explosive) without adequate protection.

The installer must ensure that EMC rules are respected, also after the instrument installation, if necessary using proper filters.

Whenever a failure or a malfunction of the device may cause dangerous situations for persons, thing or animals, please remember that the plant has to be equipped with additional devices which will guarantee safety.

### 3.2 - MECHANICAL MOUNTING

The instrument, in case 33 x 75 mm, is designed for flush-in panel mounting.

Make a hole 29 x 71 mm and insert the instrument, fixing it with the provided special bracket.

We recommend that the gasket is mounted in order to obtain the front protection degree as declared. Avoid placing the instrument in environments with very high humidity levels or dirt that may create condensation or introduction of conductive substances into the instrument.

Ensure adequate ventilation to the instrument and avoid installation in containers that house devices which may overheat or which may cause the instrument to function at a higher temperature than the one permitted and declared.

Connect the instrument as far away as possible from sources of electromagnetic disturbances such as motors, power relays, relays, solenoid valves, etc.

### 3.3 - ELECTRICAL CONNECTION

Carry out the electrical wiring by connecting only one wire to each terminal, according to the following diagram, checking that the power supply is the same as that indicated on the instrument and that the load current absorption is no higher than the maximum electricity current permitted.

As the instrument is built-in equipment with permanent connection inside housing, it is not equipped with either switches or internal devices to protect against overload of current: the installation will include an overload protection and a two-phase circuit-breaker, placed as near as possible to the instrument, and located in a position that can easily be reached by the user and marked as instrument disconnecting device which interrupts the power supply to the equipment.

It is also recommended that the supply of all the electrical circuits connected to the instrument must be protect properly, using devices (ex. fuses) proportionate to the circulating currents.

It is strongly recommended that cables with proper insulation, according to the working voltages and temperatures, be used.

Furthermore, the input cable of the probe has to be kept separate from line voltage wiring. If the input cable of the probe is screened, it has to be connected to the ground with only one side.

Whether the instrument is 12 V version it's recommended to use an external transformer TCTR, or with equivalent features, and to use only one transformer for each instrument because there is no insulation between supply and input.

We recommend that a check should be made that the parameters are those desired and that the application functions correctly before connecting the outputs to the actuators so as to avoid malfunctioning that may cause irregularities in the plant that could cause damage to people, things or animals.

**Tecnologic S.p.A. and its legal representatives do not assume any responsibility for any damage to people, things or animals deriving from violation, wrong or improper use or in any case not in compliance with the instrument's features.**

### 3.4 - ELECTRICAL WIRING DIAGRAM

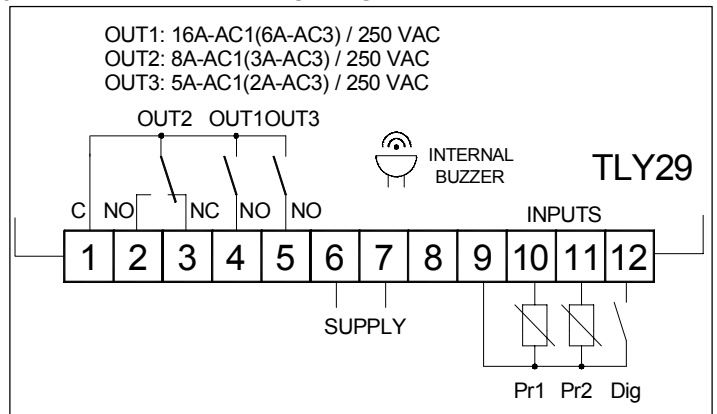

## 4 - FUNCTIONS

### 4.1 - MEASURING AND VISUALIZATION

All the parameters concerning measuring are contained in the group "InP".

Via the parameter "SEnS" it is possible to select the type of probes that one wishes to use and which can be: thermistores PTC KTY81-121 (Ptc) or NTC 103AT-2 (ntc).

Once the type of probe used has been selected, through the parameter "Unit", it is possible to select the temperature unit of measurement (°C or °F) and, through the parameter "dP", the resolution of the desired measurement (OFF=1°; On =0,1°).

The instrument allows the measuring to be calibrated, that can be used for re-calibrating the instrument according to application needs, through the parameters "OFS1" (for the probe Pr1) and "OFS2" (for the probe Pr2).

If probe Pr2 (evaporator) is not used, set the parameter "Pr 2" = OFF.

Using the parameter "FIL", it is possible to set the time constant for the software filter for measuring the input values to be able to reduce the sensitivity to measurement disturbances (increasing the time).

Through the paragraph "diSP", it is possible to fix the normal visualisation on the display that can be the measurement of the cell probe (Pr 1), the measurement of the evaporator probe (Pr 2), the set point of active regulation (SP), the current hour if the instrument has a clock (CLo) or it can have the numerical display switched off (OFF).

Regardless of what is set in the parameter "diSP", it is possible to visualise all the variables in rotation by pressing the key U, the display will alternately show the code that identifies the variable (Pr 1, Pr 2 and, if present the clock, CLo) and its value.

The exit of this visualisation mode occurs automatically 15 seconds after the last pressing on the key U.

Please remember that visualisation of the probe Pr1 can be changed by the display block in defrosting function too, by using the parameter "dLo" (see par. 4.6).

### 4.2 - OUTPUTS CONFIGURATION

The instrument outputs can be configured in the parameters group "Out" where the relative parameters "O1F", "O2F" "O3F" are found and also the parameter "buF" that allows configuration of the internal buzzer (if present).

The outputs can be configured for the following functions

= **Out** - to control the compressor or however, the temperature control device

= **dEF** - to control the defrosting device

= **FAn** - to control the fans

= **AuS** - to control the auxiliary device (see par. 4.11)

= **ALt** - to control a silenceable alarm device through a contact that is normally open, and then closed when the alarm sounds

= **AL** - to control an alarm that cannot be silenced through a contact that is normally open and closed when the alarm sounds.

= **ALL** - to control an alarm with a memory function through a contact that is normally open and closed when the alarm sounds.

= **-ALt** - to control a silenceable alarm device through a contact that is normally closed, and then open when the alarm sounds.

= **-AL** - control an alarm that cannot be silenced through a contact that is normally closed and open when the alarm sounds.

= **-ALL** - to control an alarm with a memory function through a contact that is normally closed and open when the alarm sounds (see alarm memory).

= **OFF** - Disabled output

### 4.3 - TEMPERATURE CONTROL

All the parameters concerning temperature regulation are contained in the group "rEG".

The regulation of the instrument is ON/OFF and acts on the output configured as "Out" depending on the measuring of probe Pr1, of the active Set Point "SP" (1 or 2), the intervention differential "HSEt" and the function mode "Func".

Depending on the function mode programmed on the parameter

"Func" the differential is automatically considered by the regulator with positive values for a Refrigeration control ("Func"=Cool) or with negative values for a heating control ("Func"=HEAT).

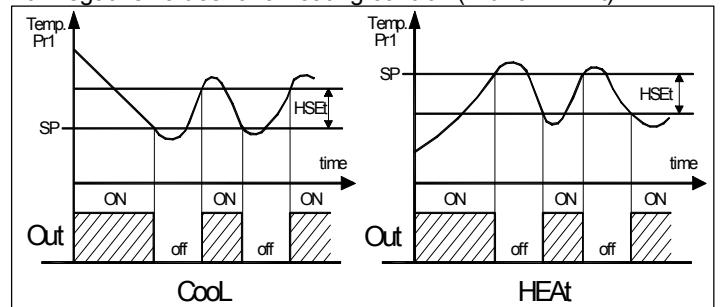

In the event of cell probe error (Pr1), it is possible to set the instrument so that that the output "Out" continues to work in cycles according to the times programmed in the parameter "tonE" (activation time) and "toFE" (deactivation time).

If an error occurs on the probe Pr1 the instrument activates the output for the time "tonE", then deactivates it for the time "toFE" and so on whilst the error remains.

Programming "tonE" = OFF the output in probe error condition will remain switched off.

Programming instead "tonE" to any value and "toFE" = OFF the output in probe error condition will remain switched on.

Remember that the temperature regulation function can be conditioned by the "Continuous Cycle", "Compressor Protection", "Minimum compressor function time", "Delay compressor start up after defrosting" and "inhibition of compressor close to defrosting" functions described below.

### 4.4 - CONTINUOUS CYCLE FUNCTION

The instrument has a continuous cycle function by which it is possible to maintain the configured output configured as "out" always active for the time set in parameter "tCC" (in the group "rEG") regardless of the temperature control command.

The function can be used for example, when rapid lowering of the product temperature is required after the refrigerator loading phase. During the continuous cycle, the defrosting is inhibited and the temperature alarms are disabled during the entire cycle and also later for the time set in parameter "dALC" (see par. 4.9).

Starting up a continuous cycle can only be done by a manual command using the U or DOWN/AUX ("UrSb" or "Fbd" = 2) keys or via the digital input ("diF"=3) if suitably programmed (see par. 4.10 and 4.12).

The continuous cycle in progress is shown on the display with the indication CC and can be stopped by a further action on the key or digital input (as for activation).

The continuous cycle function cannot be activated during defrosting and with "tCC" = OFF.

### 4.5 - COMPRESSOR PROTECTION FUNCTION AND DELAY AT POWER-ON

All the parameters concerning the compressor protection functions and the delay at power on are contained in the group "PrC".

The function "Compressor Protection" carried out by the machine aims to avoid close start ups of the compressor controlled by the instrument in cooling applications.

This function foresees a time control on the switching on of the "Out" output associated with the temperature regulation request.

The protection consists of preventing the output being switched on during the time set in the parameter "PtC" and counted depending on what has been programmed in the parameter "PSC", and therefore that any activation occurs only after the "PtC" time has finished.

If during the power on delay phase, the regulator request should disappear, due to an inhibition caused by the compressor protection function, the foreseen start up of the output is naturally cancelled.

Using the parameter "PSC", it is possible to set the type of compressor protection and therefore from when the inhibition time "PtC" must start.

The parameter "PSC" can be set as:

= 1 : Power on delay

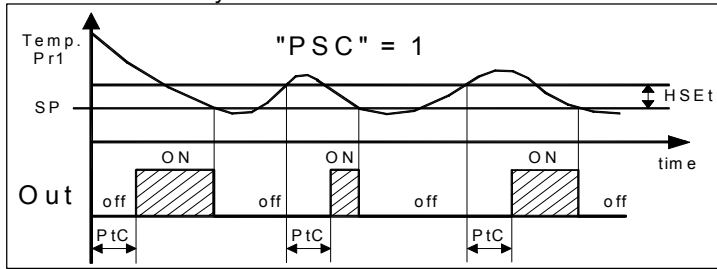

= 2 : Delay after power off

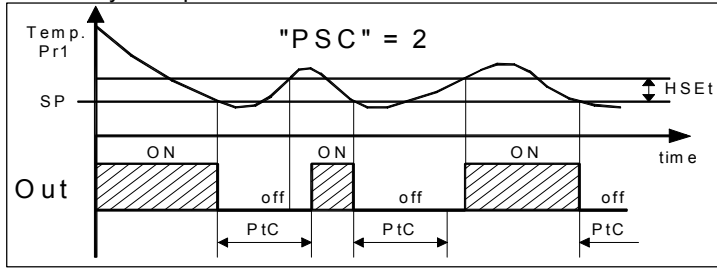

= 3 : Delay between power on phases.

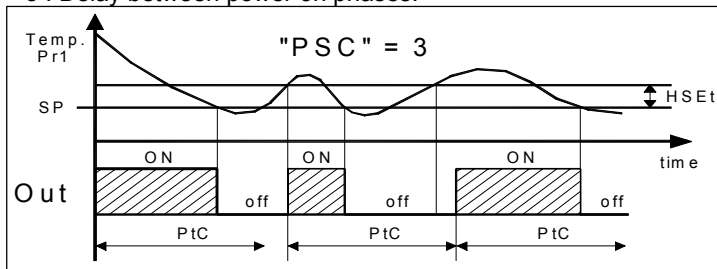

The function is disabled by programming "PtC" = 0.

Through the parameter "LCt" it is also possible to set the minimum activation time of the output to avoid switching on of the compressor that is too short.

During the power on delay phases of the OUT output by inhibiting the function "Compressor Protection" or delay of power off caused by the minimum function time "LCt", the led OUT flashes.

It is also possible to prevent activation of all the outputs after the instrument is turned on, for the time set in the parameter "od".

The function is disabled by "od" = OFF.

During the power on delay phase, the display shows the indication **od**, alternating with the normal programmed visualisation.

#### 4.6 - DEFROST CONTROL

All the parameters concerning the defrosting control that acts on the outputs configured as "Out" and "dDEF", are contained in the group "dDEF".

The type of defrosting that the instrument must carry out is set by the parameter "dtyP" that can be programmed:

= **EL** - WITH ELECTRICAL HEATING or BY STOPPING COMPRESSOR (during defrosting, the output "Out" is deactivated while the output "dDEF" is enabled)

= **in** - WITH HOT GAS or INVERSION OF CYCLE (during defrosting the outputs "Out" and "dDEF" are enabled)

The automatic defrosting can take place at intervals or if the instrument has an internal clock, at set hours.

Defrosting at intervals is possible by setting the time that runs between the two next automatic defrostings in the parameter "dint".

Counting this interval is set through the parameter "dCt" that can be programmed:

= **rt** - counts the total function time (instrument on)

= **ct** - counts only the compressor function time (output OUT switched on)

= **cS** - the instrument carries out a defrosting cycle at each compressor stop (i.e. at each deactivation of the output OUT). If this option is used, set "dint"=OFF.

if the instrument has an internal clock, it is possible to carry out up to 6 defrostings per day at set times.

To use this mode, it is necessary to set the parameter "dint"=OFF so that the defrosting at intervals is disabled and to set the parameters "dF 1", "dF 2", "dF 3", "dF 4", "dF 5", "dF 6" with the times when the defrosting must be carried out.

The automatic defrosting cycle can be at time intervals or, if an evaporator probe is used (Pr2), when a temperature is reached.

If the evaporator probe is not used (par. "Pr 2" = OFF) the duration cycle is set by the parameter "dEFE".

If instead the evaporator probe is used (parameter "Pr 2" = on) the defrosting takes place when the temperature measured by the probe exceeds the temperature set in the parameter "tEdF".

If this temperature is not reached in the time set in the parameter "dEFE", defrosting is interrupted.

In order to avoid pointless defrosting the parameter. "tSdF" is foreseen that sets the enablement temperature for defrosting

If the temperature measured by the probe is higher than the one set in the parameter "tSdF" and in the parameter "tEFE" the defrosting is inhibited.

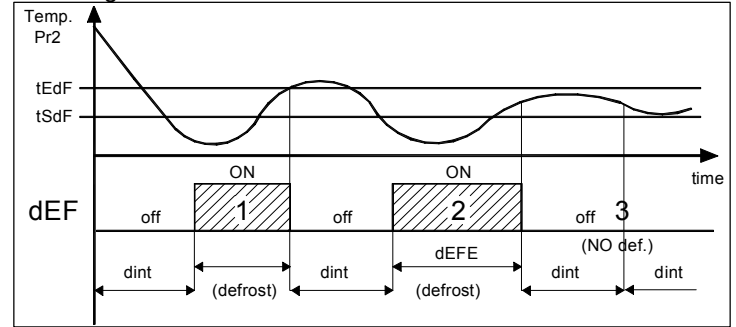

**Examples:** defrosting 1 ends due to reaching of temperature "tEdF", defrosting 2 ends at the end of the "dEFE" time as the temperature "tEdF" is not reached, defrosting 3 does not take place as the temperature is higher than "tSdF".

At the end of defrosting, it is possible to delay the new start up of the compressor (output "Out") at the time set in parameter "tdCO" to allow the evaporator to drain.

During this delay, the led Def flashes to indicate the draining state.

It is also possible to prevent start up of the compressor near to defrosting, to avoid waste of energy.

If inside the time set in the parameter "COFd" (counted in advance compared to the start up of automatic defrosting both at intervals and by clock), an activation request for the output "Out" should take place, this does not take place and it is signalled by the flashing of the Out led.

If one wishes to set a defrosting cycle every time the instrument is switched on (as long as the conditions set in the parameters "tSdF" and "tEFE" apply) programme the parameter "SdEF" = yES.

This allows the evaporator to be permanently defrosted, even when frequent interruptions to power supply occur that may cause the cancellation of the various defrosting cycles.

During the defrosting, it may occur that the temperature measured by the cell probe (Pr1) increases excessively (this obviously depends on the position of the probe Pr1 compared to the evaporator).

In the event that one does not wish this increase to be visualised by the instrument, it is possible to use the functions in the parameter "dLo" (Block display during defrosting) and "Etdu" (Differential unblocking of display after defrosting).

The parameter "dLo" = On allows the temperature Pr1 visualisation to be blocked on the last reading during a whole defrosting cycle and until the temperature does not return under the value ["SP" + "Etdu"] after defrosting has finished (or the time set in the parameter "dALd" contained in the block "AL").

With "dLo" = Lb, this allows visualisation of the writing **dDEF** during defrosting and at the end of defrosting the writing **PdEF** up to when the temperature Pr1 does not return below the value ["SP" + "Etdu"] (or the time set on the parameter "dALd" contained in the block "AL").

Alternatively with the "dLo" = OFF, during defrosting, the instrument will continue to visualise the temperature measured by the probe Pr1.

Note that during defrosting, the temperature alarms are disabled

during the whole cycle and also afterwards for the time set in the parameter "dALd" (see par. 4.9).

#### 4.7 - MANUAL DEFROST

To start up a manual defrosting cycle, press the key UP/DEFROST when it is not in programming mode and keep it pressed for about 5 seconds after which, if the conditions are correct, the led DEF will light up and the instrument will carry out a defrosting cycle.

The start up or switch off commands of a defrosting cycle can also be given by the digital input that are correctly programmed (see par. 4.10).

#### 4.8 - EVAPORATOR FANS CONTROL

All the parameters concerning fan control are contained in the group "FAn".

The control of the fans on the output configured as "FAn" depending on determined control statuses of the instrument and the temperature measured by the probe Pr2.

In the case that the probe Pr2 is not used (parameter "Pr 2" = OFF) or in error (E2 o -E2), the output FAN is activated only depending on the parameters "FCOF" and "FEdF".

The parameter "FCOF" decides whether the fans must always be switched on independently of the compressor status ("FCOF"=On) or be switched off together with the compressor ("FCOF"=OFF).

The parameter "FEdF" instead decides whether the fans must always be switched on independently of the defrosting status ("FEdF"=On) or switched off during defrosting ("FEdF"=OFF).

In this latter case, it is possible to delay the start up of the fans even after the end of the defrosting of the time set in the parameter "Fd".

When the probe Pr2 is used (par. "Pr 2" = on) the fans, as well as being conditioned by the parameters "FCOF" and "FEdF", are also conditioned by the temperature control.

It is possible to set the disablement of the fans when the temperature measured by the probe Pr2 is higher than the one set in the parameter "FLt" (temperature too hot) or when it is lower than the one set in the parameter "Fct" (temperature too cold).

The relative differential that can be set in parameter "dF" is also associated with these parameters.

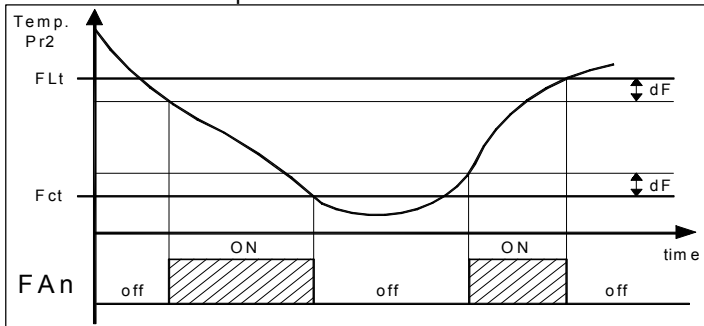

#### 4.9 - ALARM FUNCTIONS

All the parameters concerning the alarm functions are contained in group "AL".

The alarm functions of the instrument work on the internal buzzer, if present and configured via the parameter "buF", and on the output desired, if configured by the parameters "O1F", "O2F" or "O3F", depending on what is set on the said parameters.

The possible selections of these parameters for the alarm signalling function are:

= **ALt** - when one wants the buzzer or output to be activated in alarm and can be disabled (alarm silencing) manually by pressing any key of the instrument (typical application for sound signal).

= **AL** - when one wants the buzzer or output to be activated in alarm status but cannot be disabled manually and are therefore only disabled when the alarm status ceases (typical application for a light signal).

= **ALL** - when one wants the buzzer or output to be activated in alarm status and that they remain activated even when the alarm has ceased (see par.4.9.4) Disablement (recognition of memorised alarm) can only be carried out manually by pressing any key when the alarm has ended (typical application for light signal).

= **-ALt** - when one wants the function described as ALt but with an inverse function (buzzer or output activated in normal condition and disabled in alarm status).

= **-AL** - when one wants the function described as AL but with inverse logic (buzzer or output activated in normal conditions and disabled in alarm status).

= **-ALL** - when one wants the function described as ALL but with inverse working logic (buzzer or output activated in normal conditions and disabled in alarm status).

When no alarms are present, the green LED OK is lit.

Any active alarm is shown on the instrument display with the lighting up of the AL led and the switching off of the led OK.

Any silenced or memorised alarm status is shown by the AL led flashing.

The alarm conditions of the instrument are:

- Probe errors "E1", "-E1", "E2", "-E2"
- temperature alarms "HI" and "LO"
- External alarms "AL"
- Open door alarm "AP"

#### 4.9.1 - TEMPERATURE ALARMS

The temperature alarms work according to the probe Pr1 measurements, the type of alarm set in the parameter "Aty" the alarm thresholds set in parameters "HAL" (maximum alarm) and "LAL" (minimum alarm) and the relative differential "dAL".

Through the parameter "Aty" it is possible to set the alarm thresholds "HAL" and "LAL" which must be considered as absolute ("Aty"=Ab) or relative to the active Set Point ("Aty"=dE).

Using some parameters it is also possible to delay the enablement and the intervention of these alarms.

These parameters are:

"**PAL**" - is the temperature alarm exclusion time on switching on the instrument if the instrument is in alarm status when it is switched on.

"**dALd**" - is the temperature alarm exclusion time at the end of defrosting (and, if programmed, at the end of draining)

"**dALc**" - is the temperature alarm exclusion time at the end of a continuous cycle.

"**ALd**" - is the temperature alarm delay activation time

The temperature alarm is enabled at the end of exclusion time and is enabled after the "ALd" time when the temperature measured by the probe Pr1 exceeds or goes below the respective maximum and minimum alarm thresholds.

The alarm thresholds will be the same as those set on the parameters "HAL" and "LAL" if the alarms are absolute ("Aty"=Ab)

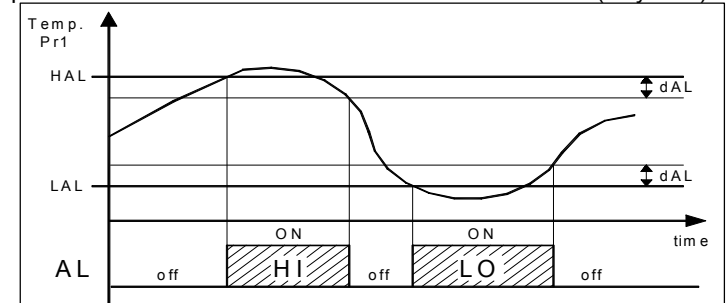

Or will be the values ["SP"+"HAL"] and ["SP"-"LAL"] if the alarms are relative ("Aty"=dE).

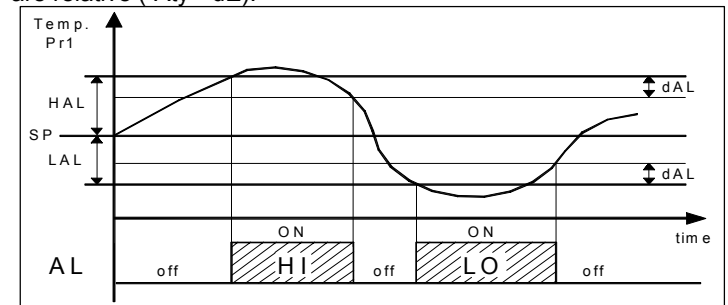

The maximum and minimum temperature alarms can be disabled by setting the relative parameters "HAL" and "LAL" = OFF.

At the same time as the signalling of the configured alarm (buzzer

and/or output), the instrument signals the alarm by turning on the led light AL, switching off the LED OK, turning on the led - in case of minimum alarm or the led + for maximum alarm, and visualises on the display:

- Alternately **HI** and the set variable in parameter "diSP" for maximum alarm
- Alternately **LO** and the set variable in parameter "diSP" for the minimum alarm

#### 4.9.2 - EXTERNAL ALARM

The instrument can signal an external alarm by activating the digital input with the function programmed as "din" = 4 or 9 (see par. 4.10).

At the same time as the signalling of the configured alarm (buzzer and/or output), the instrument signals the alarm by turning on the led AL, turning off the led OK and visualising **AL** and the variable set in parameter "diSP" alternately on the display.

#### 4.9.3 - OPEN DOOR ALARM

The instrument can signal an open door alarm by activating the digital input with the function programmed as "din" = 5 or 6 (see par. 4.10).

When the digital input is activated and after the delay programmed in parameter "oAd", the instrument signals the alarm via the activation of the configured devices (buzzer and/or output), the turning on of the led AL, the turning off of the led OK and **AP** and the variable set in parameter "diSP" are visualised alternately on the display.

#### 4.9.4 - ALARM MEMORY

The instrument offers the possibility of arranging the alarm memory function via the parameter "tAL".

If "tAL" = no, the instrument cancels the alarm signal when the alarm status ends, if instead it is programmed as "yES", the led AL flashes even when the alarm status has ended to indicate that there has been an alarm.

If the memorised alarm is for temperature, it also keeps the led - flashing to show a minimum alarm and + to show a maximum alarm.

To cancel the alarm memory signal, press any key.

It must be remembered that if an output function is desired (or the buzzer) with an alarm memory (=ALL or =-ALL) it is necessary to set the parameter "tAL" = yES.

#### 4.10 - DIGITAL INPUT

All the parameters concerning the digital input functions are contained in the group "din".

The digital input present on the instrument accepts contacts free of voltage, the function carried out is defined by the parameter "diF" and the action can be delayed for the time set in parameter "did".

The parameter "diF" can be configured for the following functions:

- = **0** - Digital input not active
- = **1** - defrosting commencement command with contact normally open: on closing the input (and after the "did" time) a defrosting cycle is activated.
- = **2** - defrosting end command with contact normally open: on closing the input (and after the "did" time) a defrosting cycle is ended if in progress or defrosting is inhibited.
- = **3** - continuous cycle activation command with contact normally open: on closing the input (and after the "did" time) a continuous cycle is started up as described in the paragraph on the continuous cycle function.
- = **4** - External alarm signal with contact normally open: on closing the input (and after the "did" time) the alarm is activated and the instrument visualises **AL** and the variable set in parameter "diSP" alternately on the display.
- = **5** - Cell door opening with fan block with contact normally open: on closing the input (and after the "did" time) the fans are stopped and the instrument visualises **AP** and the variable set in parameter "diSP" alternately on the display. With this function mode, the action of the digital input also activates the time that can be set in parameter "oAd" after which the alarm is activated to signal that the door has been left open.

= **6** - Cell door opening with compressor and fan block with contact normally open: similar to "diF" = 5 but with fan and compressor block.

= **7** - Remote control of auxiliary output AUX with contact normally open: on closing the input (and after the "did" time) the auxiliary output is activated as described in the "FOA" = 2 function mode of the auxiliary output.

= **8** - Selecting the active set point with contact normally open: on closing the input (and after the "did" time) the temperature regulation set point "SP 2" is activated. When instead the input is open the set point "SP 1" is active (see selecting active set point)

= **9** - Signalling of external alarm with disablement of all the control outputs with contact normally open: on closing the input (and after the "did" time) all the control outputs are disabled, the alarm is activated and the instrument visualises **AL** and the variable set in parameter "diSP" alternately on the display.

= **10** - Switching on/switching off (Stand-by) of instrument with contact normally open: on closing the input (and after the "did" time) the instrument is switched on while it is placed in Stand-by when opened.

= **-1** - defrosting commencement command with contact normally closed : similar to "diF"=1 but with function logic reversed.

= **-2** - defrosting end command with contact normally closed : similar to "diF"=2 but with function logic reversed.

= **-3** - continuous cycle start-up command with contact normally closed : similar to "diF"=3 but with function logic reversed.

= **-4** - External alarm signal with contact normally closed : similar to "diF"=4 but with function logic reversed.

= **-5** - Cell door opening with fan block with contact normally closed : similar to "diF"=5 but with function logic reversed

= **-6** - Cell door opening with compressor and fan block with contact normally closed : similar to "diF"=6 but with function logic reversed.

= **-7** - Remote control of auxiliary output AUX with contact normally closed : similar to "diF"=7 but with function logic reversed.

= **-8** - Selecting the active set point with contact normally closed : similar to "diF"=8 but with function logic reversed.

= **-9** - Signalling of external alarm with disablement of all the outputs with contact normally closed : similar to "diF"=9 but with function logic reversed

= **-10** - Switching on/off (Stand-by) of instrument: similar to "diF"=10 but with function logic reversed.

#### 4.11 - AUXILIARY OUTPUT

All the parameters concerning the auxiliary output functions are contained in the group "AuS".

The auxiliary output can be configured to operate on any of the outputs by programming the parameter of the desired output = AuS.

The function carried out is defined by the parameter "FOA" and the function is conditioned by the time set in parameter "tuA".

The parameter "FOA" can be configured for the following functions:

- = **0** - Auxiliary output not active
- = **1** - Regulation output delayed with contact normally open: the auxiliary output is activated with delay that can be set on the parameter "tuA" compared to the output configured as Out. The output is then turned off at the same time as the OUT output is disabled. This function mode can be used as a command for a second compressor or for all other working utilities according to the same OUT output conditions, but which must be delayed after the start up of the compressor to avoid excess electricity absorption.
- = **2** - Activation by front key (U or DOWN/AUX) or by digital input with contact normally open: the output is activated by pressing the keys U or DOWN/AUX suitably configured ("USrb" or "Fbd" = 1) or via activation of the digital input if suitably configured ("diF"=7). These commands have a bi-stable function, which means that when first pressed, the output key is activated while the second is disabled. In this mode, the AUX output can be turned off automatically after a certain time that can be set on the parameter "tuA". With "tuA" = OFF the output is activated and deactivated only manually, using the front key (U or DOWN/AUX) or via the digital input. Differently, the output, once activated, is turned off automatically after the set time. This function can be used, for example, as a cell light command, for non-misting resistance or

other utilities .

= **-1** - Delayed regulation output with contact normally closed: similar to "FOA"=1 but with function logic reversed.

= **-2** - Activation by front key (U or DOWN/AUX) or by digital input with contact normally closed: similar to "FOA"=2 but with function logic reversed.

#### 4.12 FUNCTIONING OF KEYS "U" AND "DOWN/AUX"

Two of the instrument keys, in addition to their normal functions, can be configured to operate other commands.

The U key function can be defined by the parameter "USrb" while the DOWN/AUX key function can be defined by the parameter "Fbd" both contained in the group "iPan".

Both the parameters have the same possibilities and can be configured for the following functions:

= **0** - The key carries out no function.

= **1** - Pressing the key for at least 1 second, it is possible to enable/disable the auxiliary output if configured ("FOA"=2).

= **2** - Pressing the key for at least 1 second, it is possible to enable/disable a continuous cycle (see continuous cycle function).

= **3** - Pressing the key for at least 1 second, it is possible to select one of the 2 memorised set point in rotation. Once selection has been made, the display will flash the active set point code for about 1 sec. (SP 1or SP 2).

= **4** - Pressing the key for at least 1 second, it is possible to switch the instrument from the ON status to Stand-by status and vice versa.

#### 4.13 - PARAMETERS CONFIGURATION BY "KEY01"

The instrument is equipped with a connector that allows the transfer from and toward the instrument of the functioning parameters through the device **TECNOLOGIC KEY01** with **5 poles** connector.

This device it's mainly useable for the serial programming of the instruments which need to have the same parameters configuration or to keep a copy of the programming of an instrument and allow its rapid retransmission.

To use the device KEY01 it's necessary that the device or instrument are being supplied.

##### Instrument supplied and device not supplied

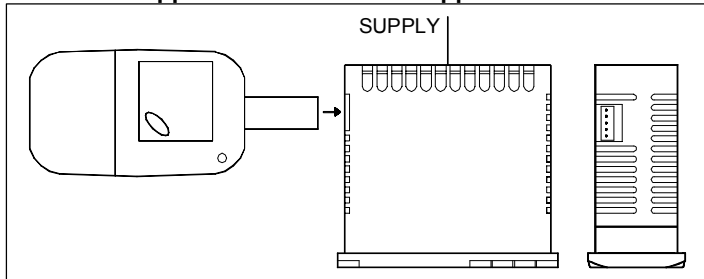

##### Instrument supplied from the device

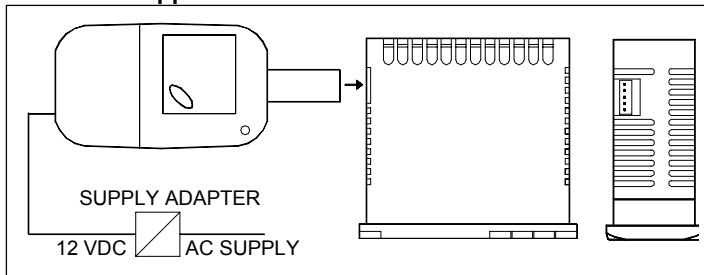

To transfer the configuration of an instrument into the device (**UPLOAD**) it is necessary to proceed in the following way:

1) position both dip switch of KEY 01 in the **OFF** mode.

2) connect the device to the instrument TLY plugging the special connector.

3) verify that the instrument or the device are supplied

4) observe the indication led on the device KEY 01: if it results green this means that a configuration is already loaded on the device while if it results green blinking or red blinking this means that it has not been loaded any valid configuration on the device .

5) press the button placed on the device.

6) observe the indication led : after having pressed the button, the led becomes red and therefore, at the end of the data transfer, it becomes green.

7) now it is possible to disconnect the device.

To transfer the configuration loaded on the device onto an instrument of the same family (**DOWNLOAD**), it is necessary to proceed in the following way:

1) position both dip switch of KEY 01 in the **ON** mode.

2) connect the device to an instrument TLY having the same features of the one from which has been downloaded the desired configuration, plugging the special connector.

3) verify that the instrument or the device are supplied

4) observe the indication led on the device KEY 01: it has to result green, because if the led results green blinking or red blinking, this means that on the device it has not been downloaded any valid configuration and therefore it's useless to continue.

5) if the les results green, press the button placed on the device.

6) observe the indication led : after having pressed the button, the led becomes red and therefore, at the end of the data transfer, it becomes green.

7) now it is possible to disconnect the device.

*For additional info, please have a look at the KEY01 instruction manual.*

## 5 - PROGRAMMABLE PARAMETERS TABLE

Here below is a description of all the parameters available on the instrument. Some of them may not be present, either due to the fact they depend on the type of instrument or because they are automatically disabled as unnecessary.

### Group <sup>1</sup>SP (parameters relative to Set Point)

Par.	Description	Range	Def.	Note
1	<b>SPAt</b> Active Set point	1 ÷ 2	1	
2	<b>SP1</b> Set Point 1	SPLL ÷ SPHL	0.0	
3	<b>SP2</b> Set Point 2	SPLL ÷ SPHL	0.0	
4	<b>SPLL</b> Minimum Set Point	-58 ÷ SPHL	-50.0	
5	<b>SPHL</b> Maximum Set Point	SPLL ÷ 302	100.0	

### Group <sup>1</sup>InP (parameters relative to measuring inputs)

Par.	Description	Range	Def.	Note
6	<b>SEnS</b> Probes Type	Ptc - ntc	Ptc	
7	<b>OFS1</b> Pr1 Probe (cell) Calibration	-30 ÷ 30 °C/°F	0.0	
8	<b>OFS2</b> Pr2 Probe (evaporator) Calibration	-30 ÷ 30 °C/°F	0.0	
9	<b>Pr 2</b> Pr2 Probe Presence (evaporator)	On - OFF	On	
10	<b>Unit</b> Unit of measurement	°C - °F	°C	
11	<b>dP</b> Decimal point	On - OFF	On	
12	<b>FiL</b> Measurement filter	OFF ÷ 20.0 sec	2.0	
13	<b>diSP</b> Variable visualized normally on display: OFF=Display off Pr1= measurement probe Pr1 Pr2= measurement probe Pr2 SP= Active Set Point CL= Clock time	OFF - Pr1 - Pr2 - SP - CL	Pr1	

### Group <sup>1</sup>rEG (parameters relative to temperature control)

Par.	Description	Range	Def.	Note
14	<b>HSEt</b> Differential	0 ÷ 30 °C/°F	2.0	
15	<b>tonE</b> Activation time output OUT for probe Pr1 broken	OFF ÷ 99.59 min.sec	OFF	



16	<b>toFE</b>	Deactivation time output OUT for probe Pr1 broken	OFF ÷ 99.59 min.sec	OFF	
17	<b>Func</b>	Function mode output OUT	HEAt - Cool	Cool	
18	<b>tCC</b>	Continuous cycle Time	OFF ÷ 99.59 hrs.min	OFF	

**Group 1dEF** (parameters relative to defrosting control)

Par.	Description	Range	Def.	Note
19	<b>dytP</b> Defrosting Type: EL = electrical in = hot gas/reverse cycle	EL - in	EL	
20	<b>dint</b> Defrosting interval	OFF ÷ 99.59 hrs.min	6.00	
21	<b>dF 1</b> Time start defrost 1	OFF - 00.00 ÷ 23.59 hrs.min	OFF	
22	<b>dF 2</b> Time start defrost 2	OFF - 00.00 ÷ 23.59 hrs.min	OFF	
23	<b>dF 3</b> Time start defrost 3	OFF - 00.00 ÷ 23.59 hrs.min	OFF	
24	<b>dF 4</b> Time start defrost 4	OFF - 00.00 ÷ 23.59 hrs.min	OFF	
25	<b>dF 5</b> Time start defrost 5	OFF - 00.00 ÷ 23.59 hrs.min	OFF	
26	<b>dF 6</b> Time start defrost 6	OFF - 00.00 ÷ 23.59 hrs.min	OFF	
27	<b>dEFE</b> Max. length of defrost cycle	0.01 ÷ 99.59 min.sec	30.00	
28	<b>tEdF</b> Defrost stop temperature	- 58 ÷ 302 °C/°F	8.0	
29	<b>tSdF</b> Defrost enable temperature	- 58 ÷ 302 °C/°F	2.0	
30	<b>dCt</b> Defrosting intervals Counting mode	rt - ct - cS	rt	
31	<b>tdCO</b> Compressor delay after defrost (drainage time)	OFF ÷ 99.59 min.sec	OFF	
32	<b>SdEF</b> Defrost at power on	no - yES	no	
33	<b>dLo</b> Defrost display Lock OFF= display free On= Lock on temperature Pr1 before defrost Lb= Lock on label "dEF" (during defrosting) and "PdEF" (during post-defrosting)	On - OFF - Lb	OFF	
34	<b>Etdu</b> Differential display unlock after defrost	0 ÷ 30 °C/°F	2.0	
35	<b>COFd</b> Time compressor off before defrost	OFF ÷ 99.59 min.sec	OFF	

**Group 1FAn** (parameters relative to evaporator fan control)

Par.	Description	Range	Def.	Note
36	<b>FCOF</b> Fan status with compressor off	On - OFF	On	
37	<b>FEdF</b> Fan status during defrost	On - OFF	OFF	
38	<b>FLt</b> High temperature fan off	- 58 ÷ 302 °C/°F	2.0	
39	<b>Fct</b> Low temperature fan off	- 58 ÷ 302 °C/°F	-50.0	
40	<b>dF</b> Differential fan control	0 ÷ 30 °C/°F	2.0	
41	<b>Fd</b> Fan delay after defrost	OFF ÷ 99.59 min.sec	OFF	

**Group 1PrC** (parameters relative to compressor protection and power on delay)

Par.	Description	Range	Def.	Note
42	<b>PSC</b> Type of compressor protection: 1= delay at switch on 2= delay after switch off 3= delay between starts	1 - 2 - 3	1	
43	<b>PtC</b> Compressor protection time	OFF ÷ 99.59 min.sec	OFF	
44	<b>LtC</b> Minimum compressor function time	OFF ÷ 99.59 min.sec	OFF	
45	<b>od</b> Delay at power on	OFF ÷ 99.59 min.sec	OFF	

**Group 1AL** (parameters relative to alarms)

Par.	Description	Range	Def.	Note
46	<b>Aty</b> Temperature alarms Type: Ab = Absolute dE =Relative to Set	Ab - dE	Ab	
47	<b>HAL</b> High temperature Alarm threshold	OFF / - 58 ÷ 302 °C/°F	OFF	
48	<b>LAL</b> Low temperature Alarm threshold	OFF / - 58 ÷ 302 °C/°F	OFF	
49	<b>dAL</b> Temperature Alarms Differential	0 ÷ 30 °C/°F	2.0	
50	<b>ALd</b> Temperature Alarms delay	OFF ÷ 99.59 min.sec	OFF	
51	<b>tAL</b> Alarm memory	no - yES	no	
52	<b>PAL</b> Temperature Alarms delay at power on	OFF ÷ 99.59 hrs.min	2.00	
53	<b>dALd</b> Temperature Alarms delay and unlock display delay after defrost	OFF ÷ 99.59 hrs.min	1.00	
54	<b>dALc</b> Temperature alarms delay after continuous cycle	OFF ÷ 99.59 hrs.min	OFF	
55	<b>oAd</b> Alarm delay with open door	OFF ÷ 99.59 min.sec	OFF	

**Group 1din** (parameters relative to digital input)

Par.	Description	Range	Def.	Note
56	<b>diF</b> Function and function logic of digital input: 0 = No function 1= Start defrost 2= End defrost 3= Continuous cycle 4= External alarm 5= Door open with fan block 6= Door open with fan and compressor block 7= Auxiliary output command 8= Selection of active Set Point 9= External alarm with deactivation of control outputs 10= Switch on/Switch off (Stand-by)	-10 / -9 / -8 / -7 / -6 / -5 / -4 / -3 / -2 / -1 / 0 / 1 / 2 / 3 / 4 / 5 / 6 / 7 / 8 / 9 / 10	0	
57	<b>did</b> Delay in acquiring digital input	OFF ÷ 99.59 min.sec	OFF	

**Group <sup>1</sup>AuS** (parameters relative to auxiliary output)

Par.	Description	Range	Def.	Note
58	<b>FOA</b> Function mode auxiliary output: 0= No Function 1= regulation output delayed 2= manual activation by key or digital input.	0 / 1 / 2 / -1 / -2	0	
59	<b>tuA</b> Time relative to auxiliary output	OFF ÷ 99.59 min.sec	OFF	

**Group <sup>1</sup>Out** (parameters relative to configuration of outputs)

Par.	Description	Range	Def.	Note
60	<b>Out1</b> Configuration of output function OUT1: OFF= No function Out= Temperature control (compressor) dEF= defrosting FAn= fans AuS= Auxiliary ALt= Silenceable alarm AL= Alarm not silenceable ALL= memorised alarm	OFF/Out/dEF/ FAn/AuS/ALt/ AL/ALL/ -ALt/ -AL/ -ALL	Out	
61	<b>Out2</b> Configuration of output function OUT2: see "Out1"	OFF/Out/dEF/ FAn/AuS/ALt/ AL/ALL/ -ALt/ -AL/ -ALL	dEF	
62	<b>Out3</b> Configuration of output function OUT3: see "Out1"	OFF/Out/dEF/ FAn/AuS/ALt/ AL/ALL/ -ALt/ -AL/ -ALL	FAn	
63	<b>buF</b> Configuration Buzzer function: see "Out1"	OFF/Out/dEF/ FAn/AuS/ALt/ AL/ALL/ -ALt/ -AL/ -ALL	ALt	

**Group <sup>1</sup>PAn** (parameters relative to configuration of the keyboard)

Par.	Description	Range	Def.	Note
64	<b>Fbd</b> Function mode key DOWN/AUX: OFF= No function 1= Auxiliary output command 2= Continuous cycle command 3= Selection of active Set Point 4= Switch on/Switch off (Stand-by)	OFF / 1 / 2 / 3 / 4	OFF	
65	<b>USrb</b> Function mode key U: see "Fbd"	OFF / 1 / 2 / 3 / 4	OFF	
66	<b>PASS</b> Access Password to parameter functions	OFF ÷ 9999	OFF	

**Group <sup>1</sup>CLO** (parameters relative to the internal clock)

Par.	Description	Range	Def.	Note
67	<b>StCL</b> Current time	0.00 ÷ 23.59 hrs.min	0.00	
68	<b>CLOF</b> Daily calibration of clock	-20 ÷ 20 sec	0	

**6 - PROBLEMS, MAINTENANCE AND GUARANTEE****6.1 - SIGNALLING****Error Signalling:**

Error	Reason	Action
<b>E1</b> <b>-E1</b>	The probe Pr1 may be interrupted or in short circuit, or may measure a value outside the range allowed	Check the correct connection of the probe with the instrument and check the probe works correctly
<b>E2</b> <b>-E2</b>	The probe Pr2 may be interrupted or in short circuit, or may measure a value outside the range allowed	
<b>EEPr</b>	Internal memory error	Check and if necessary re-programme the parameters function.

In Cell probe error status, the output OUT behaves as set by the parameters "tonE" and "toFE".

**Other Signalling:**

Message	Reason
<b>od</b>	Delay in switching on in progress
<b>dEF</b>	Defrosting in progress with "dLo"=Lb
<b>PdEF</b>	Post-defrosting in progress with "dLo"=Lb
<b>CC</b>	Continuous cycle in progress
<b>HI</b>	Maximum temperature alarm in progress
<b>LO</b>	Minimum temperature alarm in progress
<b>AL</b>	Digital input alarm in progress
<b>AP</b>	Door open

**6.2 - CLEANING**

We recommend cleaning of the instrument with a slightly wet cloth using water and not abrasive cleaners or solvents which may damage the instrument.

**6.3 - GUARANTEE AND REPAIRS**

The instrument is under warranty against manufacturing flaws or faulty material, that are found within 12 months from delivery date.

The guarantee is limited to repairs or to the replacement of the instrument.

The eventual opening of the housing, the violation of the instrument or the improper use and installation of the product will bring about the immediate withdrawal of the warranty's effects.

In the event of a faulty instrument, either within the period of warranty, or further to its expiry, please contact our sales department to obtain authorisation for sending the instrument to our company.

The faulty product must be shipped to TECNOLOGIC with a detailed description of the faults found, without any fees or charge for Tecnologic, except in the event of alternative agreements.

**7 - TECHNICAL DATA****7.1 - ELECTRICAL DATA**

**Power supply:** 12 VAC/VDC, 24 VAC/VDC, 100..240 VAC +/- 10%

**Frequency AC:** 50/60 Hz

**Power consumption:** 3 VA approx.

**Input/s:** 2 inputs for temperature probes: PTC (KTY 81-121, 990 Ω @ 25 °C) or NTC (103AT-2, 10KΩ @ 25 °C); 1 digital input for free voltage contacts

**Output/s:** 3 relay outputs: OUT1 SPST-NO (16A-AC1, 6A-AC3 250 VAC), OUT2 SPDT (8A-AC1, 3A-AC3 250 VAC), and OUT3 SPST-NO (5A-AC1, 2A-AC3 250 VAC). 16 A Max. for common (pin. 1)

**Electrical life for relay outputs:** 100000 operat. (VDE om.)

**Installation category:** II

**Measurement category:** I

**Protection class against electric shock:** Class II for Front panel

**Insulation:** Reinforced insulation between the low voltage part (supply H type and relay outputs) and front panel; Reinforced insulation between the low voltage section (supply type H and relay outputs) and the extra low voltage section (inputs); Reinforced between supply and relay outputs; No insulation between supply F

type and inputs.

## 7.2 - MECHANICAL DATA

Housing: Self-extinguishing plastic, UL 94 V0

Dimensions: 33 x 75 mm, depth 64 mm

Weight: 115 g approx.

Mounting: Flush in panel in 29 x 71 mm hole

Connections: 2,5 mm<sup>2</sup> screw terminals block

Degree of front panel protection : IP 65 mounted in panel with gasket

Pollution situation: 2

Operating temperature: 0 ... 50 °C

Operating humidity: 30 ... 95 RH% without condensation

Storage temperature: -10 ... +60 °C

## 7.3 - MECHANICAL DIMENSIONS, PANEL CUT-OUT AND MOUNTING [mm]

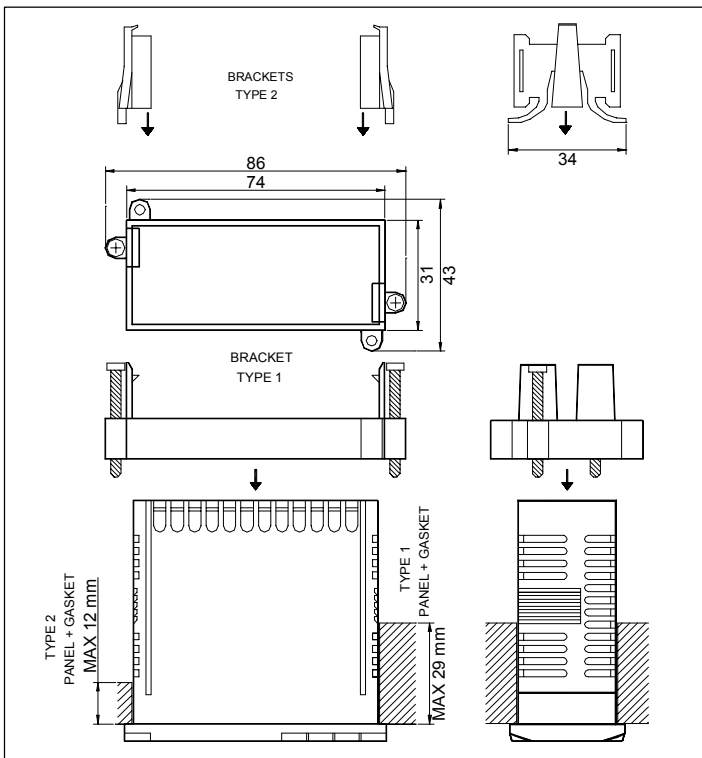
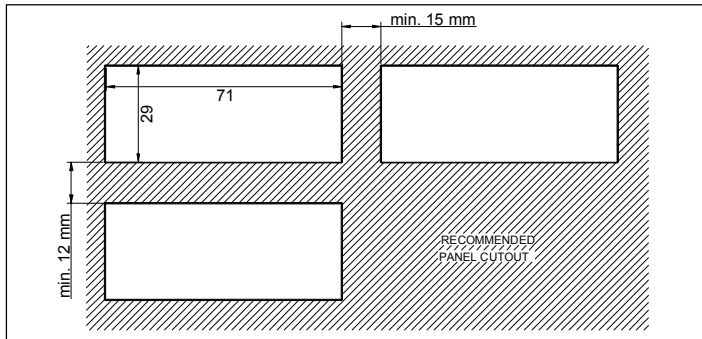
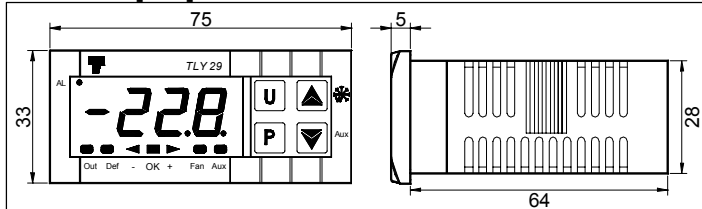

## 7.4 - FUNCTIONAL FEATURES

Temperature Control: ON/OFF mode

Defrost control: interval cycles or at programmed times (Real Time Clock Defrosting) by Electric Heating or hot-gas / reverse cycle

Measurement range: PTC: -50...150 °C / -58 ... 302 °F;

NTC: -50...109 °C / -58...228 °F

Display resolution: 1 ° or 0,1°

Overall accuracy: +/- 0,5 % fs

Sampling rate: 130 ms.

Display: 4 Digit Red h 12 mm

Endurance time of the internal clock without power supply: 4 hours approx. by internal condenser

Compliance: ECC directive EMC 89/336 (EN 61326), ECC directive LV 73/23 and 93/68 (EN 61010-1)

## 7.6 - INSTRUMENT ORDERING CODE

**TLY 29 - a b c dd**

**a : POWER SUPPLY**

H = 100...240 VAC

L = 24 VAC/VDC

F = 12 VAC/VDC

**b : INTERNAL BUZZER**

B = Yes

- = No

**c : REAL TIME CLOCK DEFROSTING**

C = Yes

- = No

**dd : SPECIAL CODES**