

PT100 PROBE COMPLETE WITH IP68 ALUMINIUM CONNECTION HEAD. Supplied with SEM206P in head transmitter.

FIBERGLASS INNARDS

PROBE TYPE: PT100 CLASS B

6MM DIAMETER

300MM LONG

M20 X 1.5 CONDUIT ENTRY  
 HEAD MATERIAL: ALUMINIUM  
 PROTECTION PROBE MATERIAL: ST/  
 STEEL 316

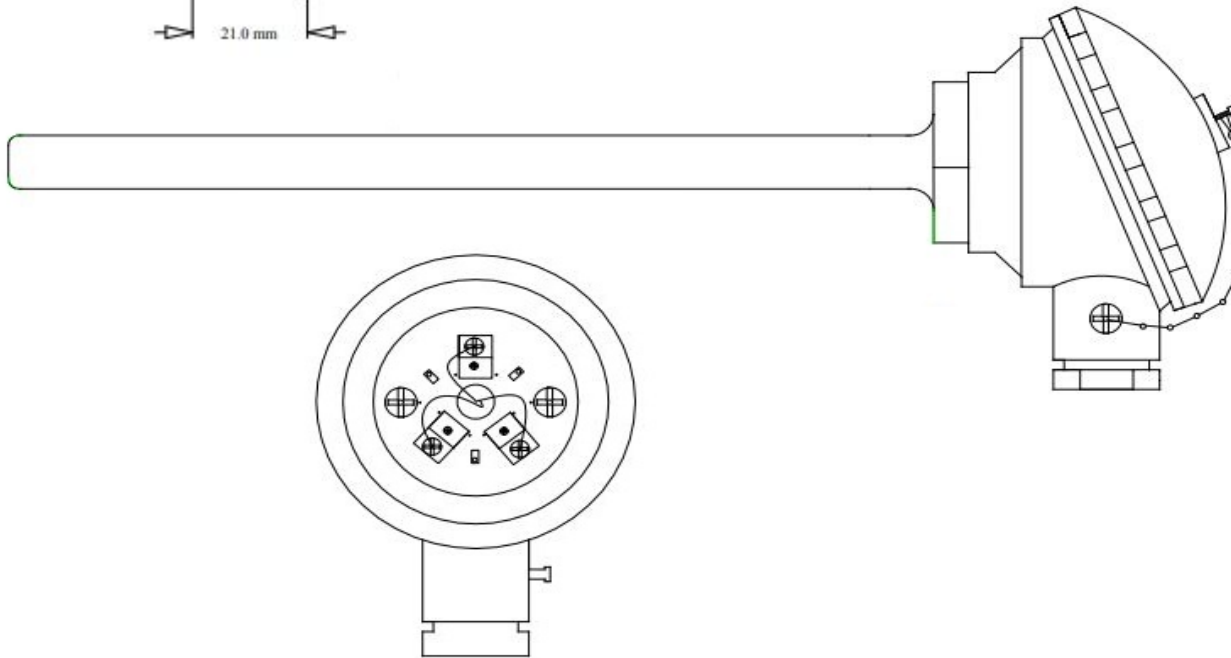

\*THESE HEADS ARE IDEAL FOR HOUSING A TRANSMITTER OR TO GIVE A BASIC PROBE MORE MECHANICAL\*

DATE: 2018	DRAWN BY: JM	MATERIAL: Material <not specified>	SHEET: 1 OF 1	SIZE	
				<b>A</b>	
DRWG NO: PT100B-6MMx150MM- HEAD-FG AND SEM206P	TITLE: PT100B-6MMx150MM-HEAD-FG AND SEM206P				